



Ministry of Higher Education and Scientific Research  
University of Salahaddin  
College of Engineering  
Architectural department



# Water supply and Sanitary System

Lect. By: assist. Lect. Sakar Yousif

30.4.2023

# Contents

- Water supply

Service pipe

Supply pipe

Hot and cold water supplies

- Sanitary Appliances

Soil appliances

Waste water appliances

Roof drainage

Surface water Drainage

# WATER SUPPLY

Water is supplied by the 'statutory water undertaker' required to supply a constant, potable (drinkable) supply of water for which service either a water rate is charged for domestic consumption or a charge by meter for most other users.

## Service pipe

The house or building service pipe connection is made to the main and the service pipe is run to a stop valve near to the site boundary of the building to be served. The stop valve is situated either immediately outside or inside the boundary.

## Supply pipe

The pipe that is run from the stop valve to and into the building is termed a supply pipe. The supply pipe is run underground and into the building as illustrated in Fig.

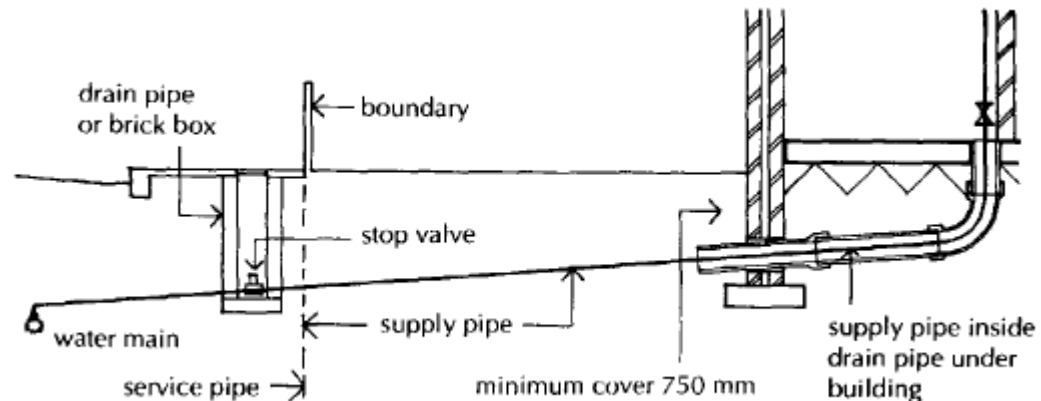

# Diagram I

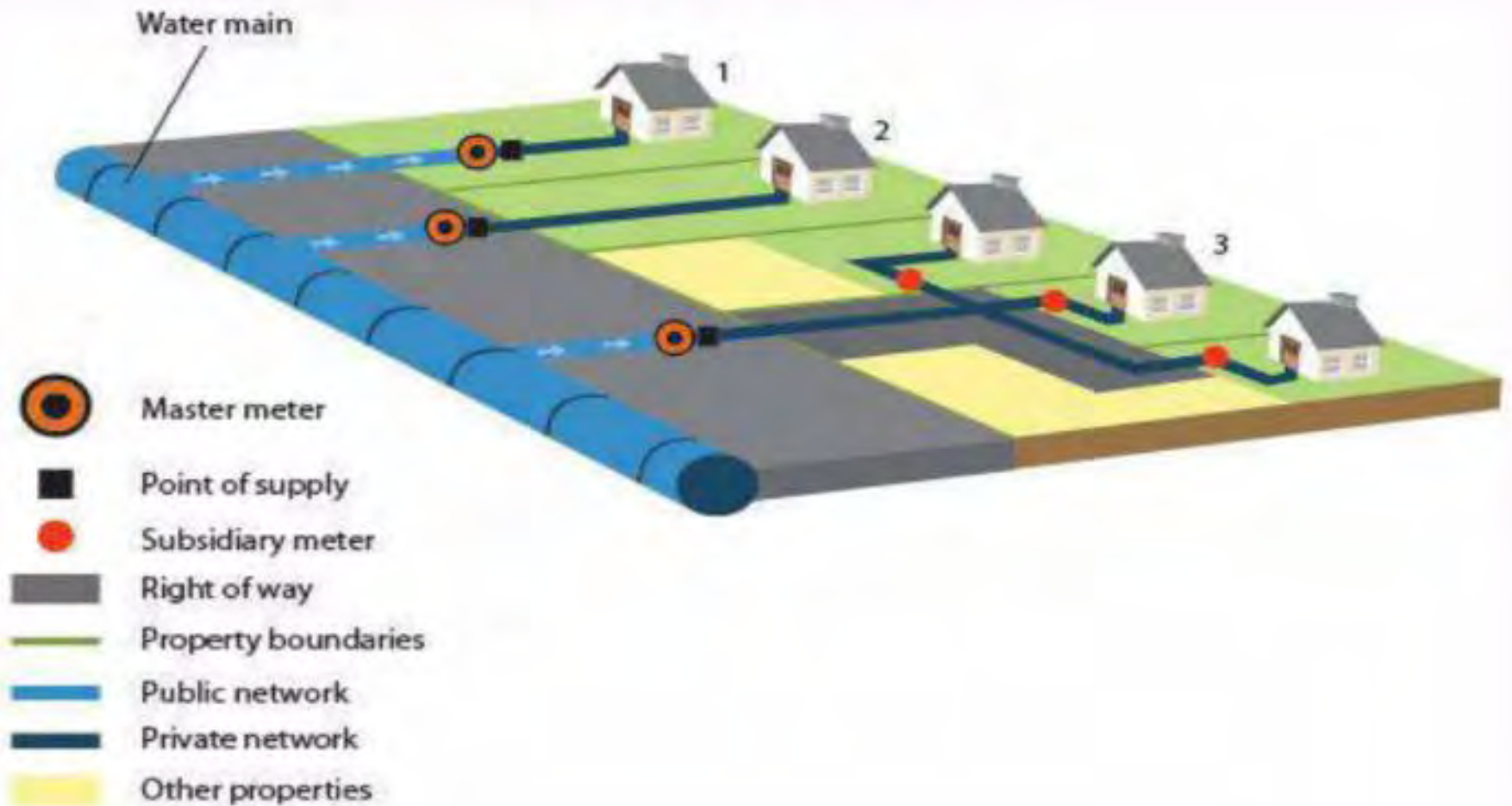

# HOT AND COLD WATER SUPPLIES

## Cold water supply:

The intermittent supply of water that was common from the middle of the eighteenth to the middle of the twentieth century necessitated the use of a water storage cistern fixed at high level in each building to maintain a constant supply of cold water. These cisterns were designed to contain one or more days' use of water in the building, to allow for interruption in the supply.

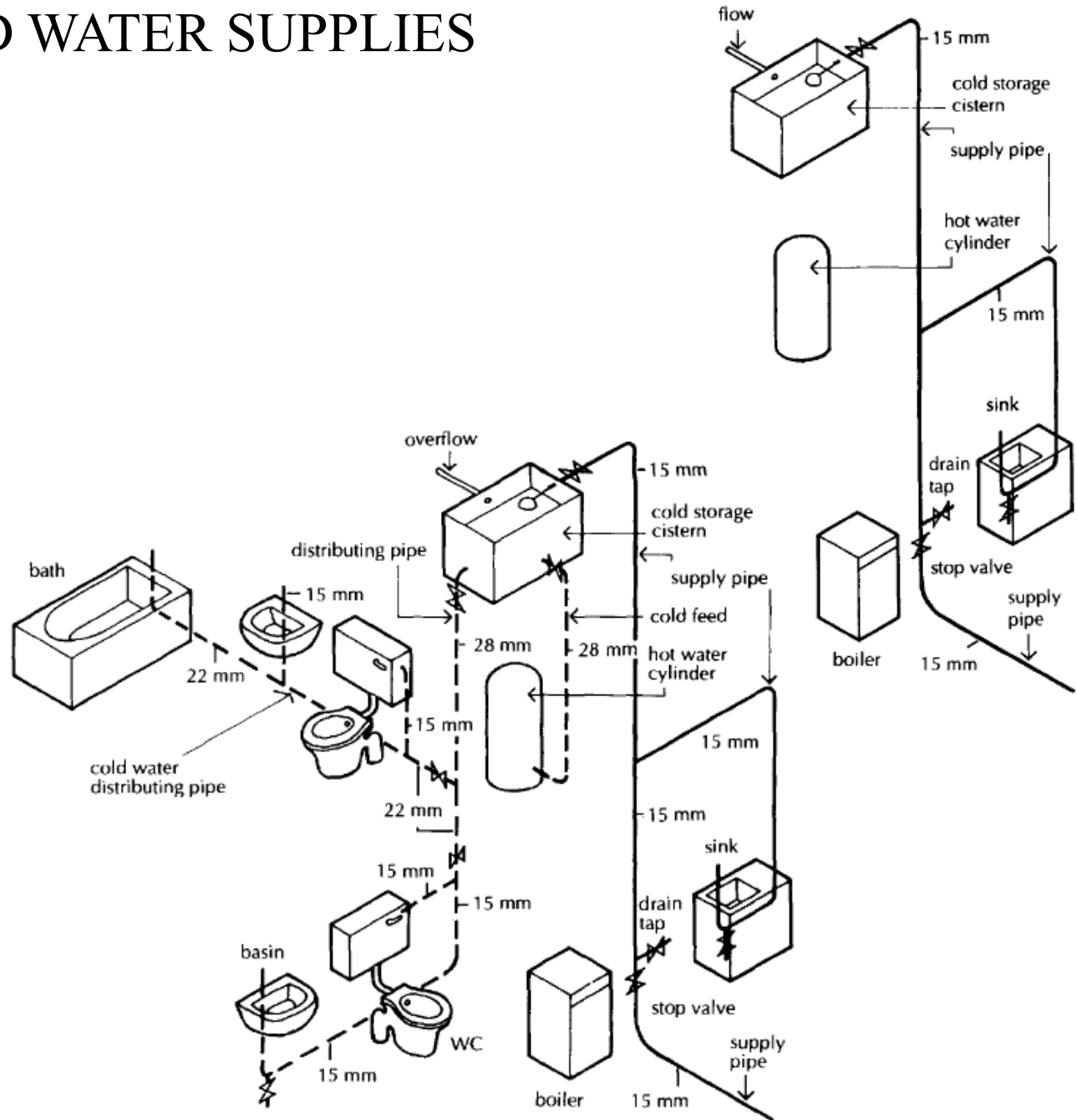

# HOT AND COLD WATER SUPPLIES

## Hot water supply:

The figure illustrates the hot water distributing pipe system for a two storey house. The hot water is drawn from a cylinder which is fed by cold water drawn from the cold water storage cistern in the roof.

The cold water in the hot water cylinder is heated by a heat exchanger in the cylinder through which hot water circulates from the boiler. The cold water feed to the cylinder is run through a stop valve to the bottom of the cylinder.

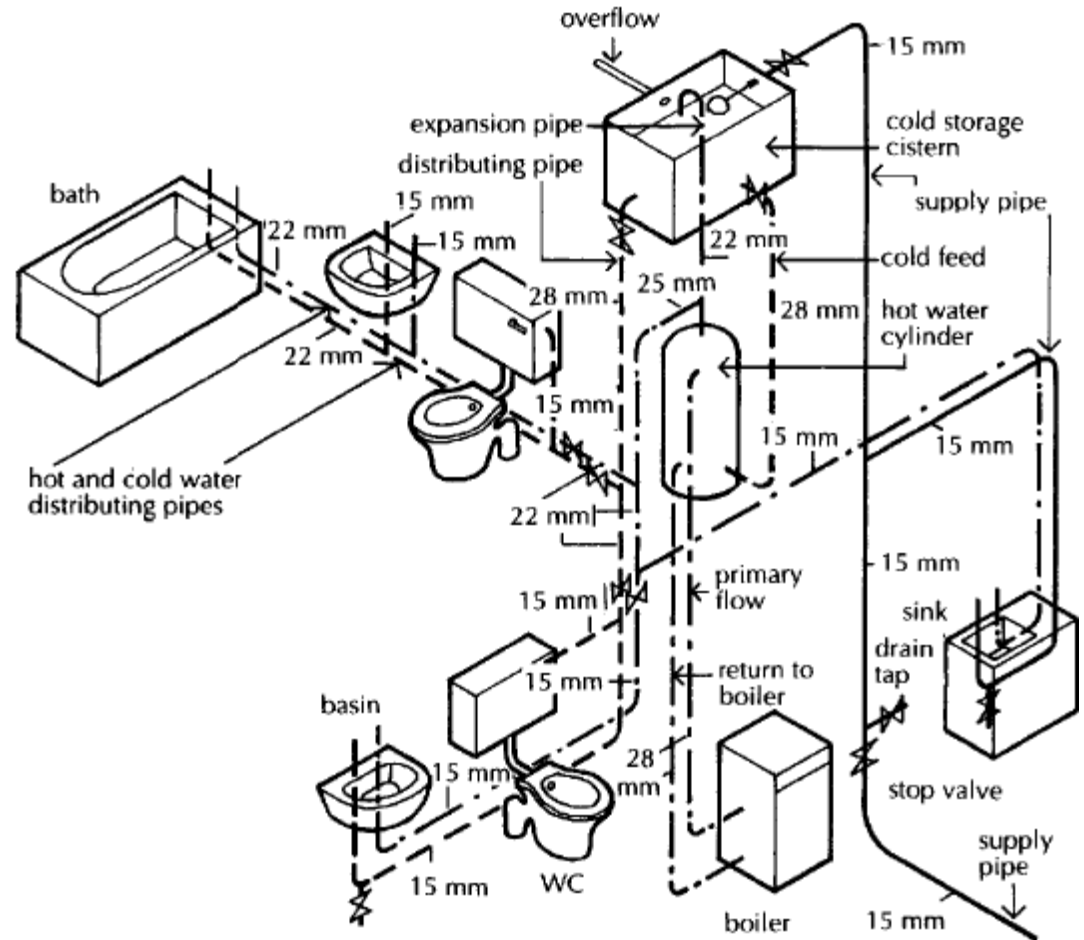

# Diagram II

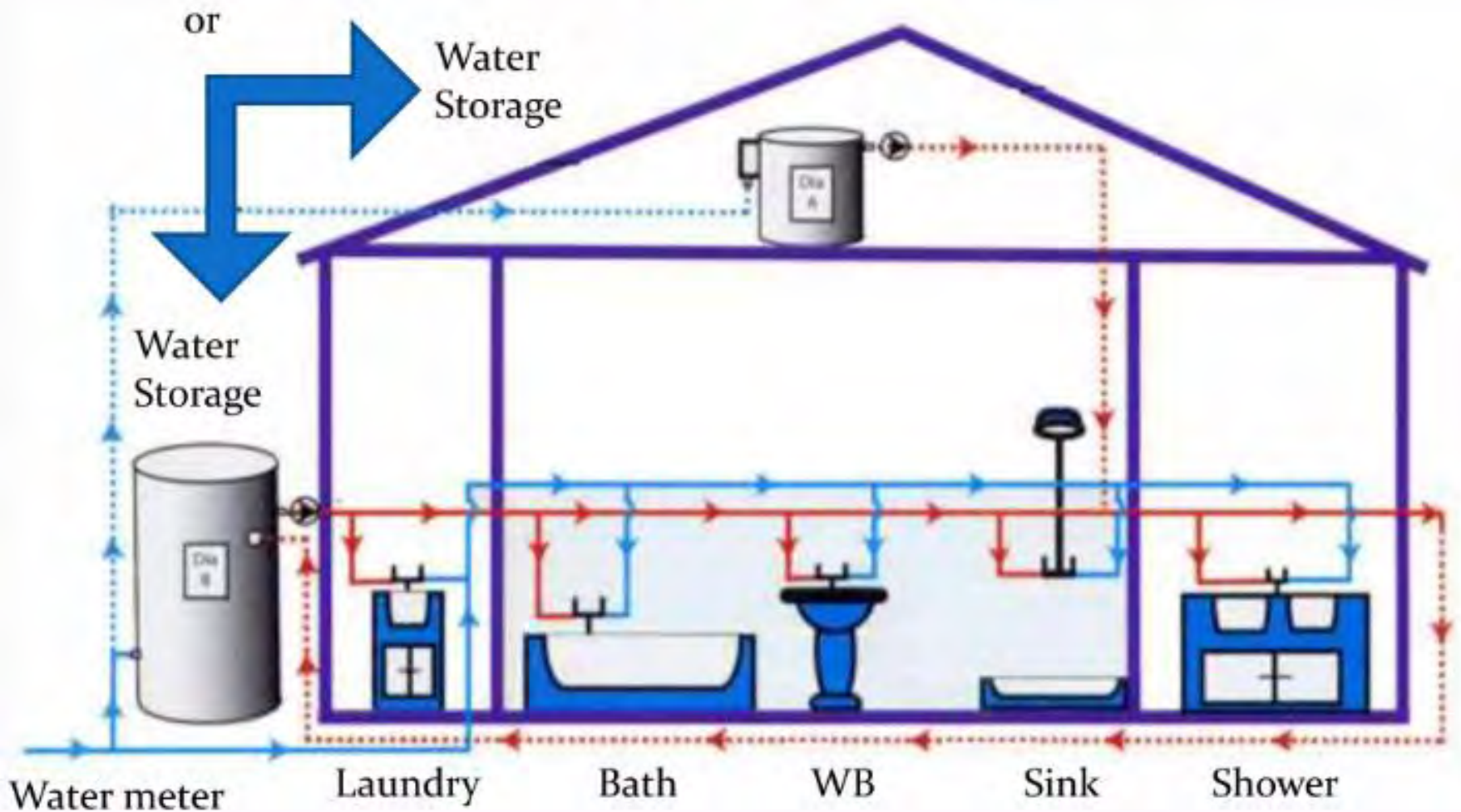

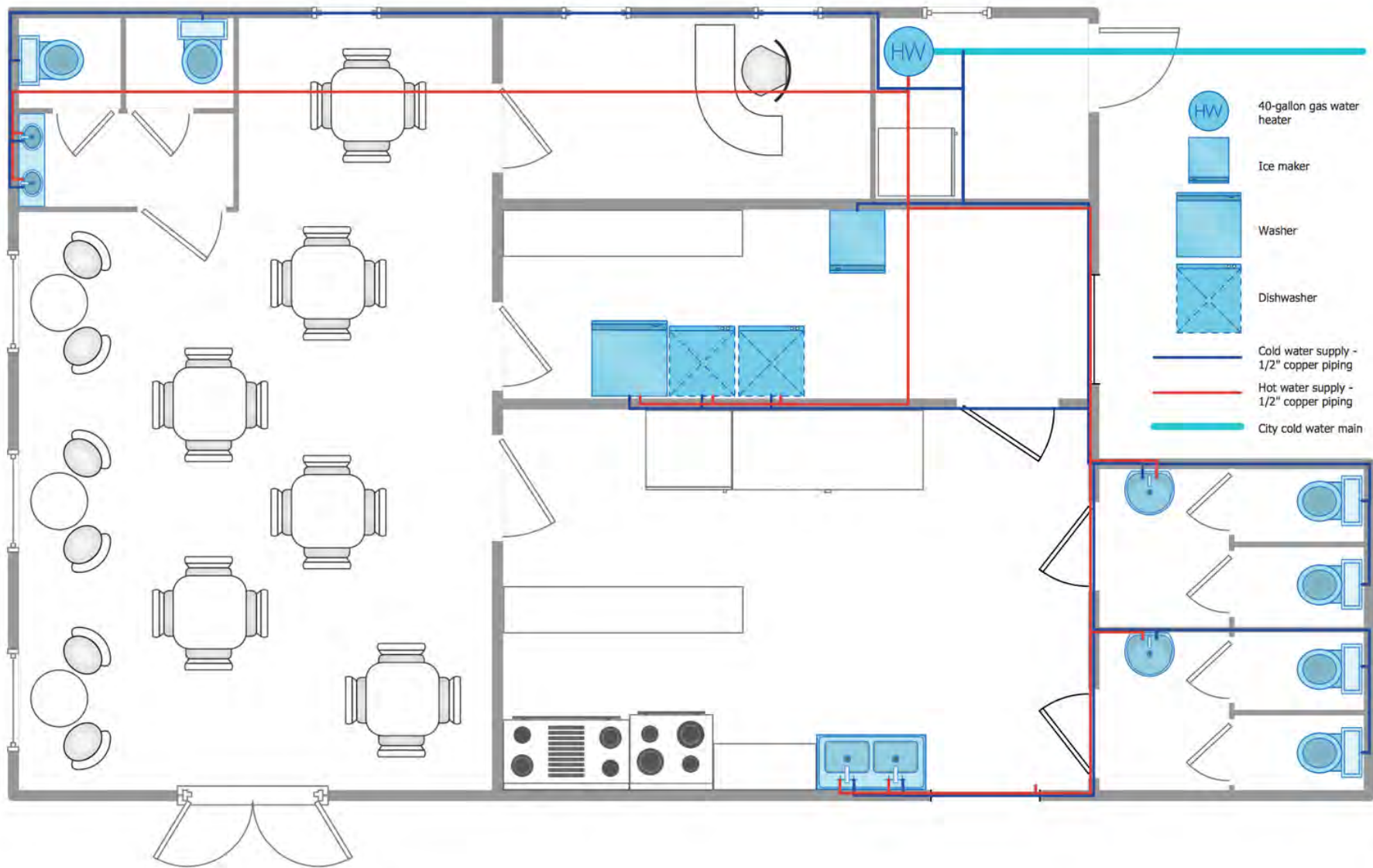



# HOT AND COLD WATER SUPPLIES

A typical house plumbing system

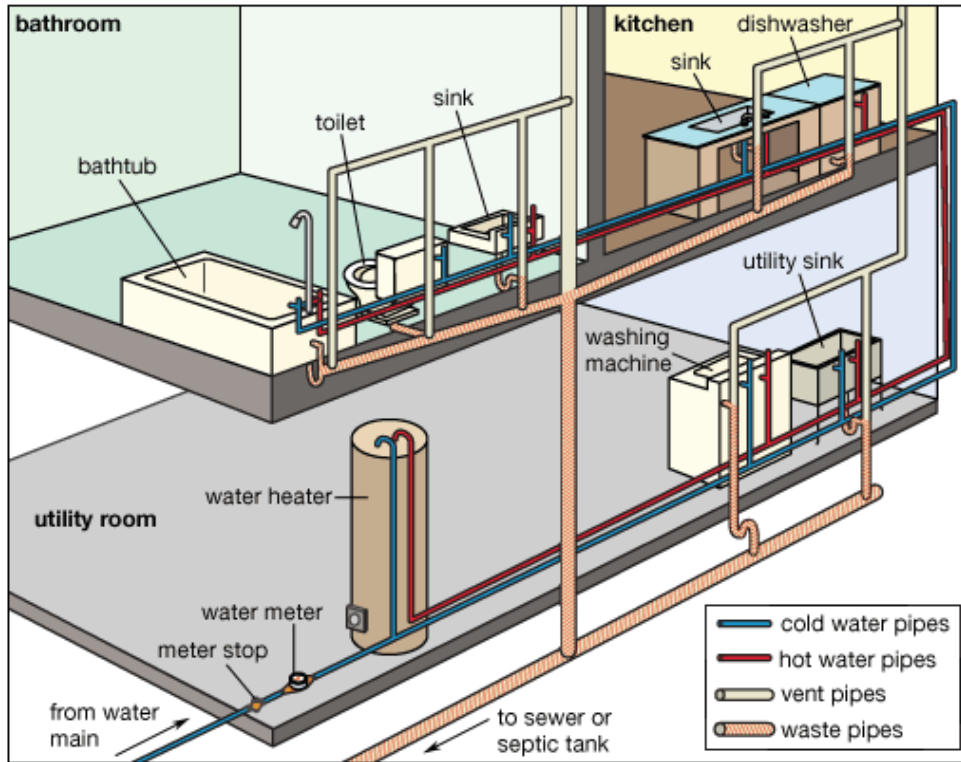

© 2007 Encyclopædia Britannica, Inc.

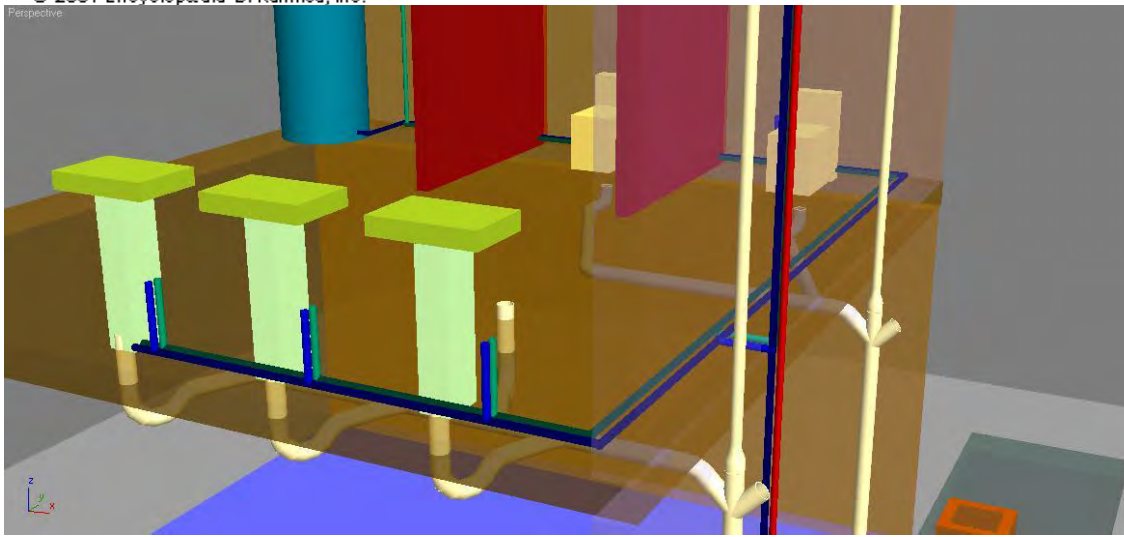



Street

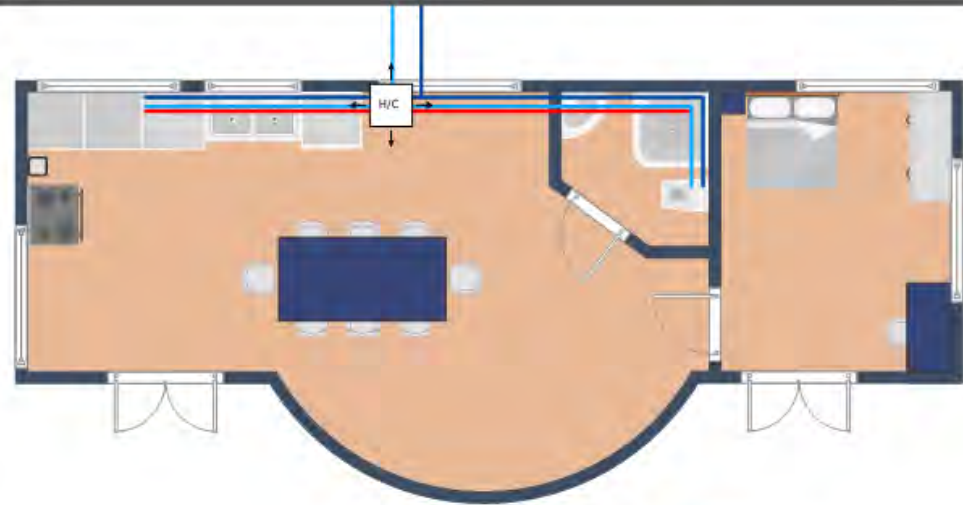

# SANITARY APPLIANCES

Sanitary appliances, sometimes termed sanitary fittings, include all fixed appliances in which water is used either for flushing foul matter away or in which water is used for cleaning, culinary and drinking purposes. The former, termed soil appliances, include WCs and urinals, the discharge from which is described as soil, or soiled or foul water. The second type, termed waste appliances, includes washbasins, baths, showers, sinks and bidets, the discharge from which is described as waste water..

## SOIL APPLIANCES

### W.C suite

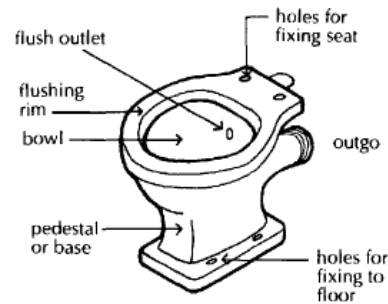
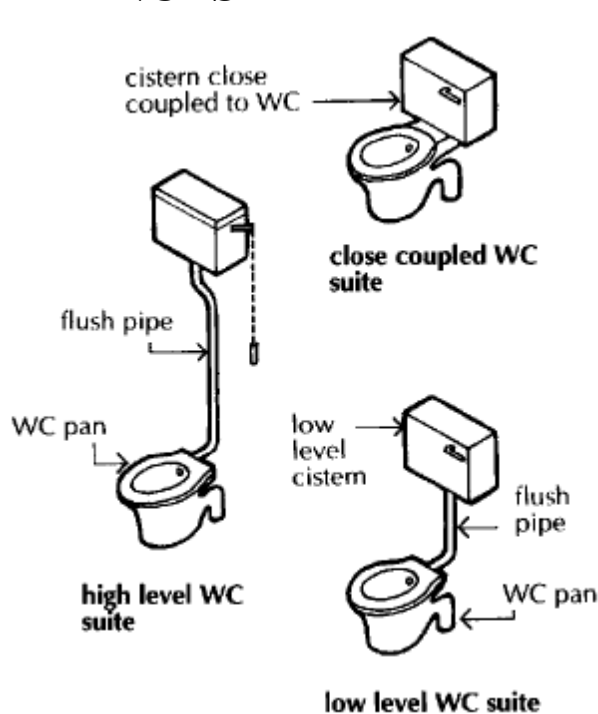

Fig. 53 Pedestal WC pan.

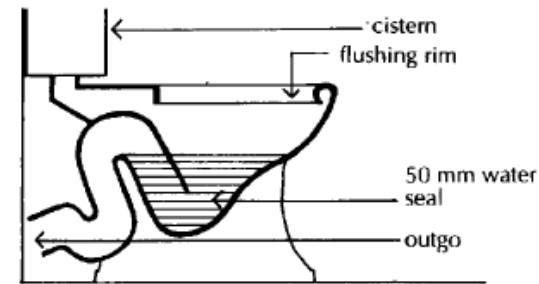
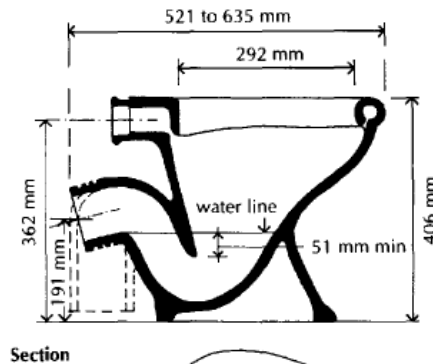

Fig. 55 Single seal siphon WC pan.

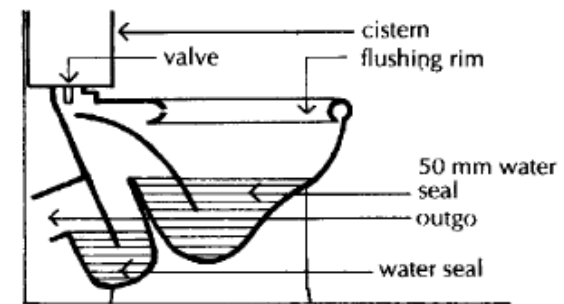
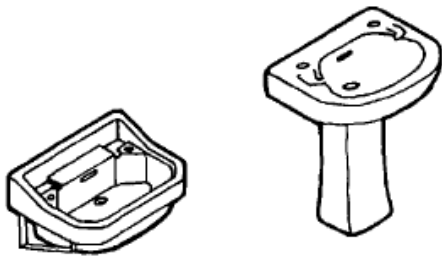

Fig. 56 Double seal siphonic WC pan.

# SANITARY APPLIANCES

## WASTE WATER APPLIANCES

### Wash basins



Wash basin fixed on wall brackets

Wash basin on pedestal

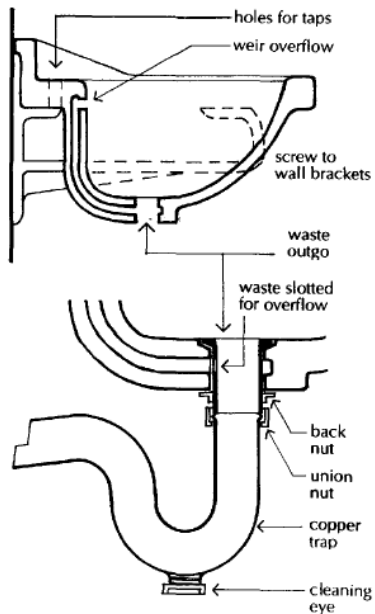
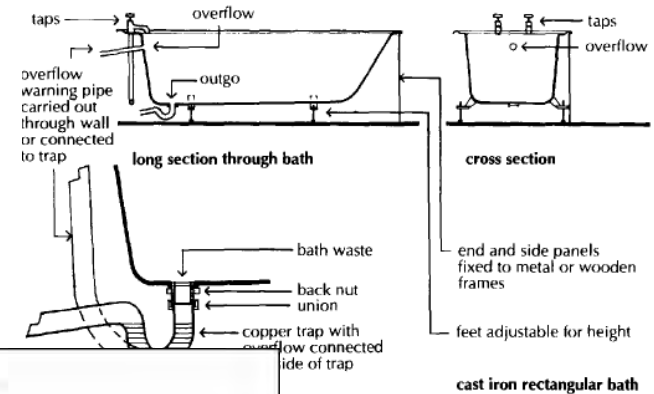
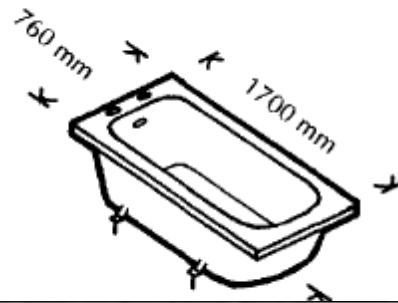

Fig. 75 Wash basin waste and trap.

Waste or waste water appliances include basins, baths, sinks and bidets.

Wash basins, designed for washing the upper part of the body, are supported by wall brackets or by a pedestal secured to the floor,

### Baths



### Soil stack versus waste stack

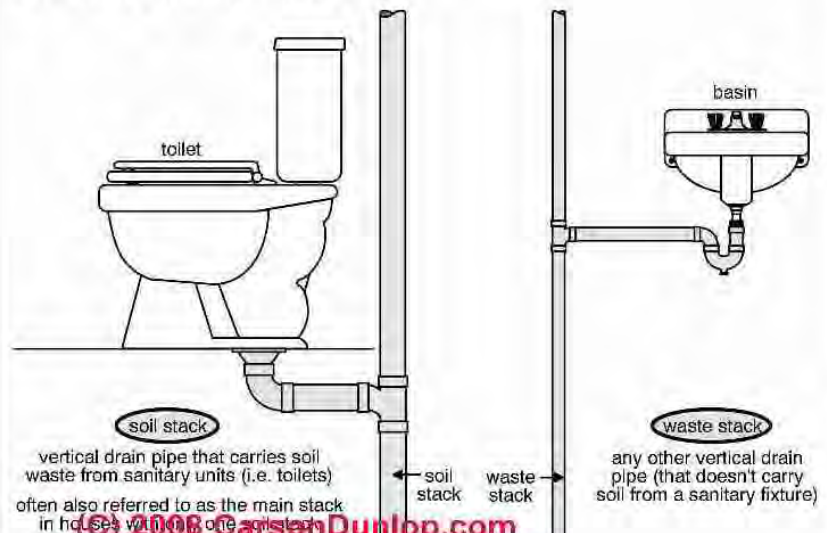

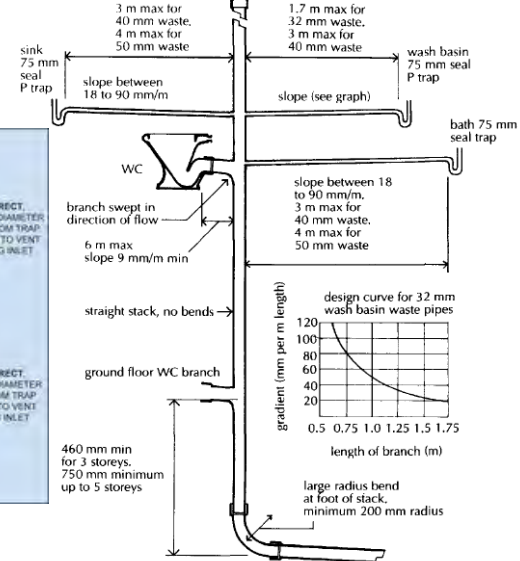
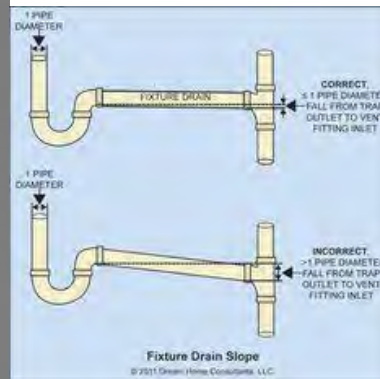
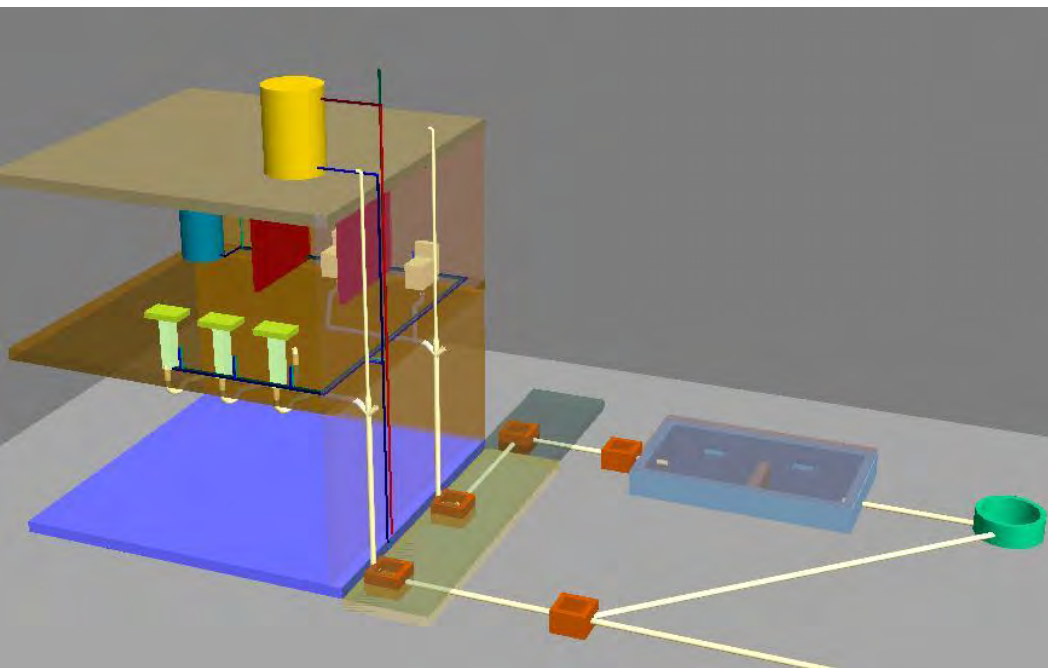

Ground level

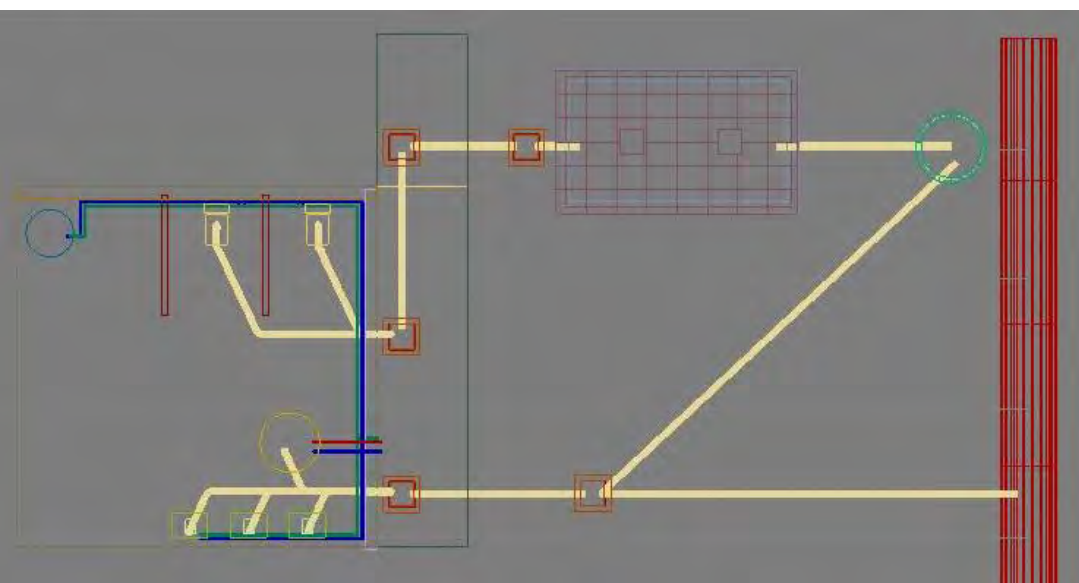
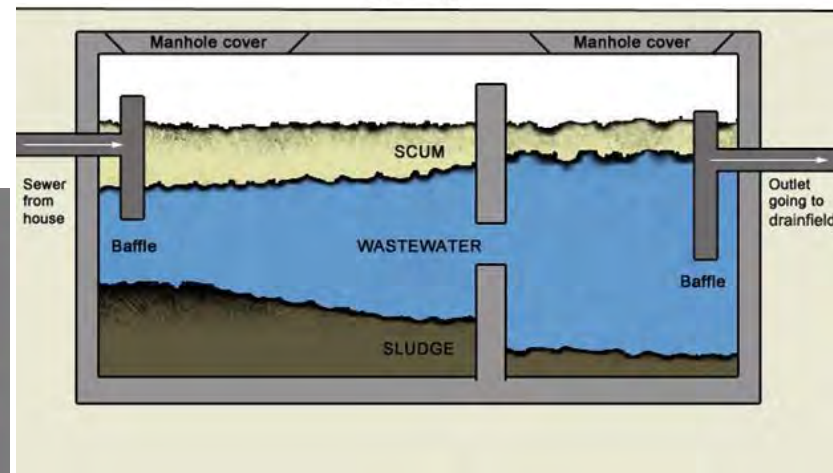

# Design of Septic Tanks

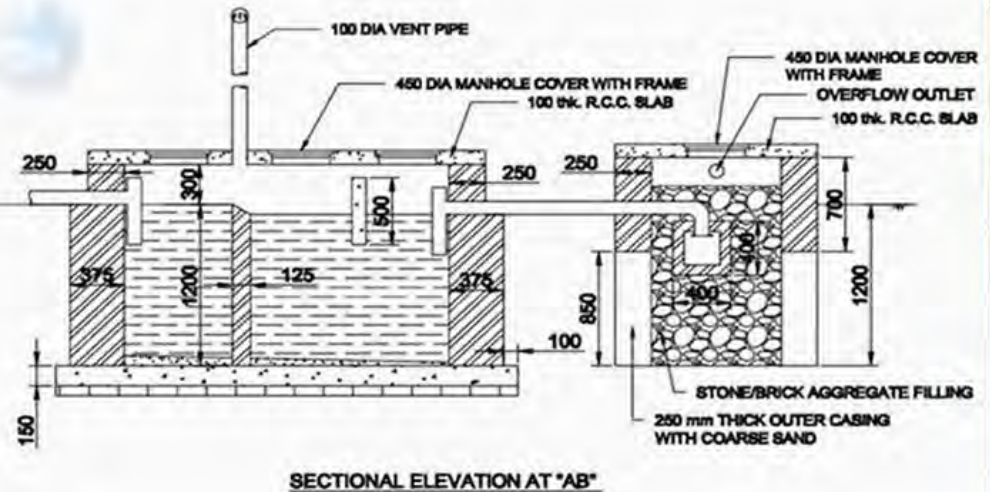
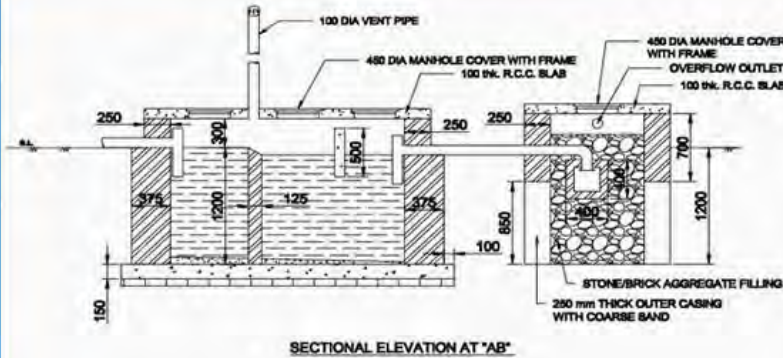

How to Design a Septic Tank

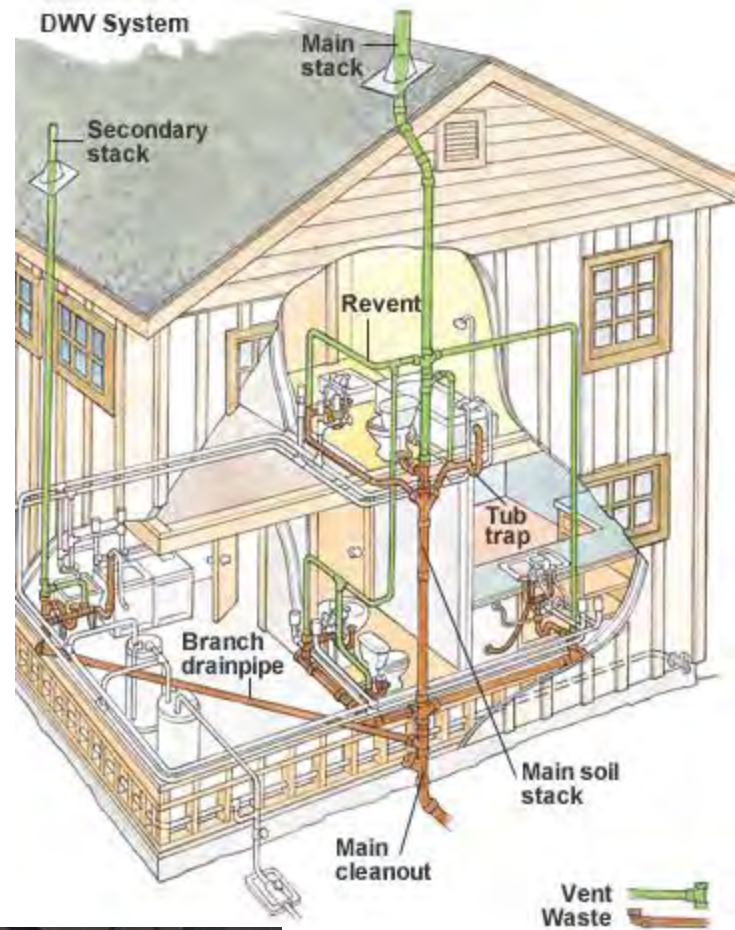
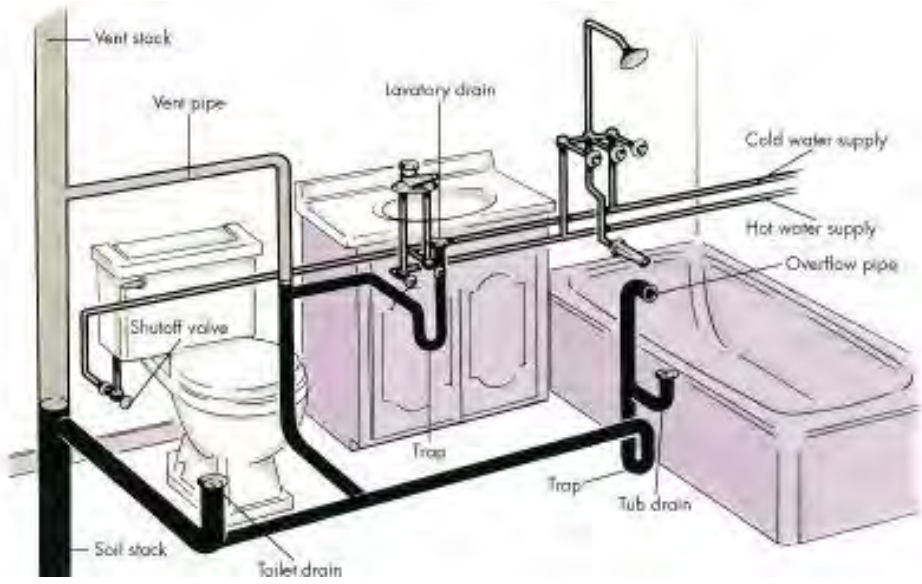

# Sewerage Systems Types

- It is the system and infrastructure of collecting, treating and disposal of sewage.

**There are three sewerage systems types:-**

- 1. Separate System
- 2. Partially Separated System
- 3. Combined System



# 1. Separate Sewerage System

- In this system the sanitary sewage and storm water are carried separately in two sets of sewers.
- The sewage is conveyed to waste water treatment plant (WWTP) and the storm water is discharged into rivers without treatment.
- The separated system is suitable when separate outlet for storm water is available and the topography is such that storm water can be disposed of in natural drains

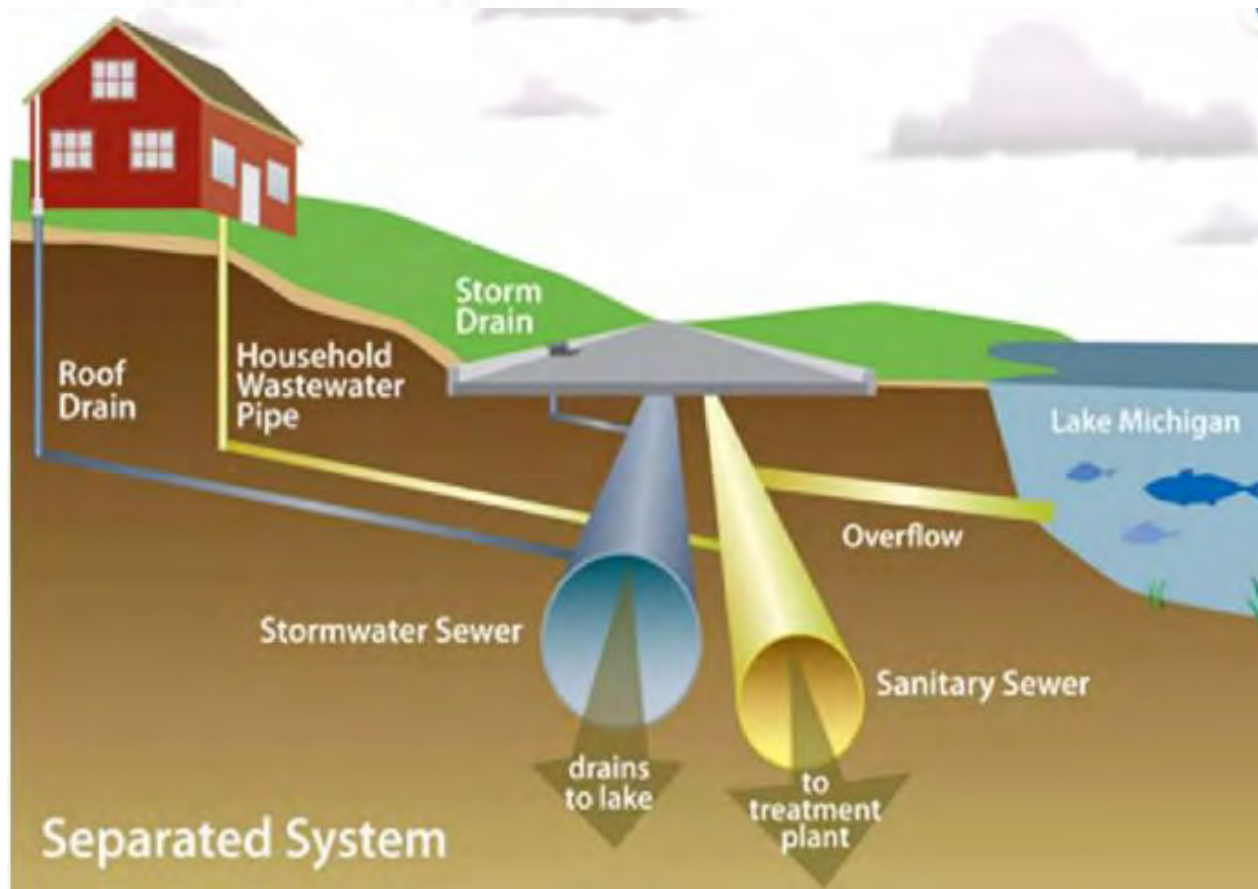

## 2. Partially Separate Sewerage System

- This system is the compromise between separate and combine system taking the advantages of both systems.
- In this system the sewage and storm water of buildings are carried by one set of sewers while the storm water from roads, streets, pavements etc are carried by other system of sewers usually open drains.

**Partially Separate System of Underground Drainage**

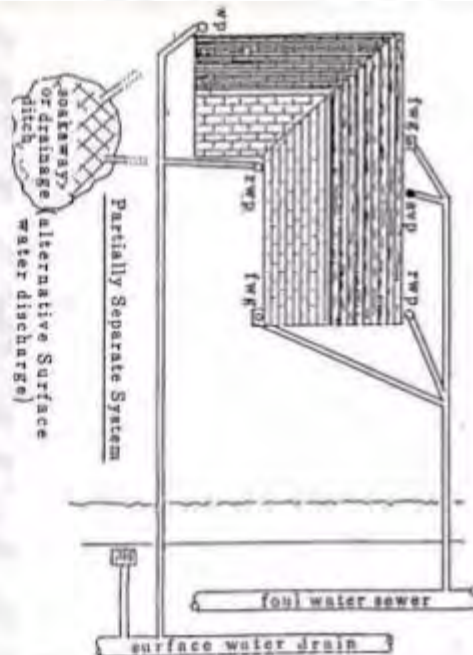

**Partially Separate System of Underground Drainage**

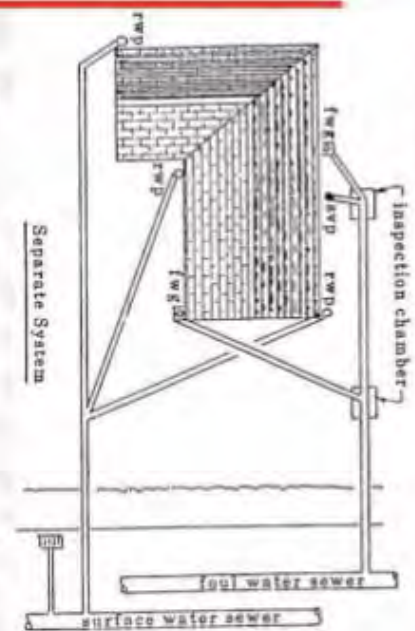

### 3. Combined Sewerage System

- In this system the sewage and storm water are carried combine in only one set of sewers to the waste water treatment Plant (WWTP) before disposal.

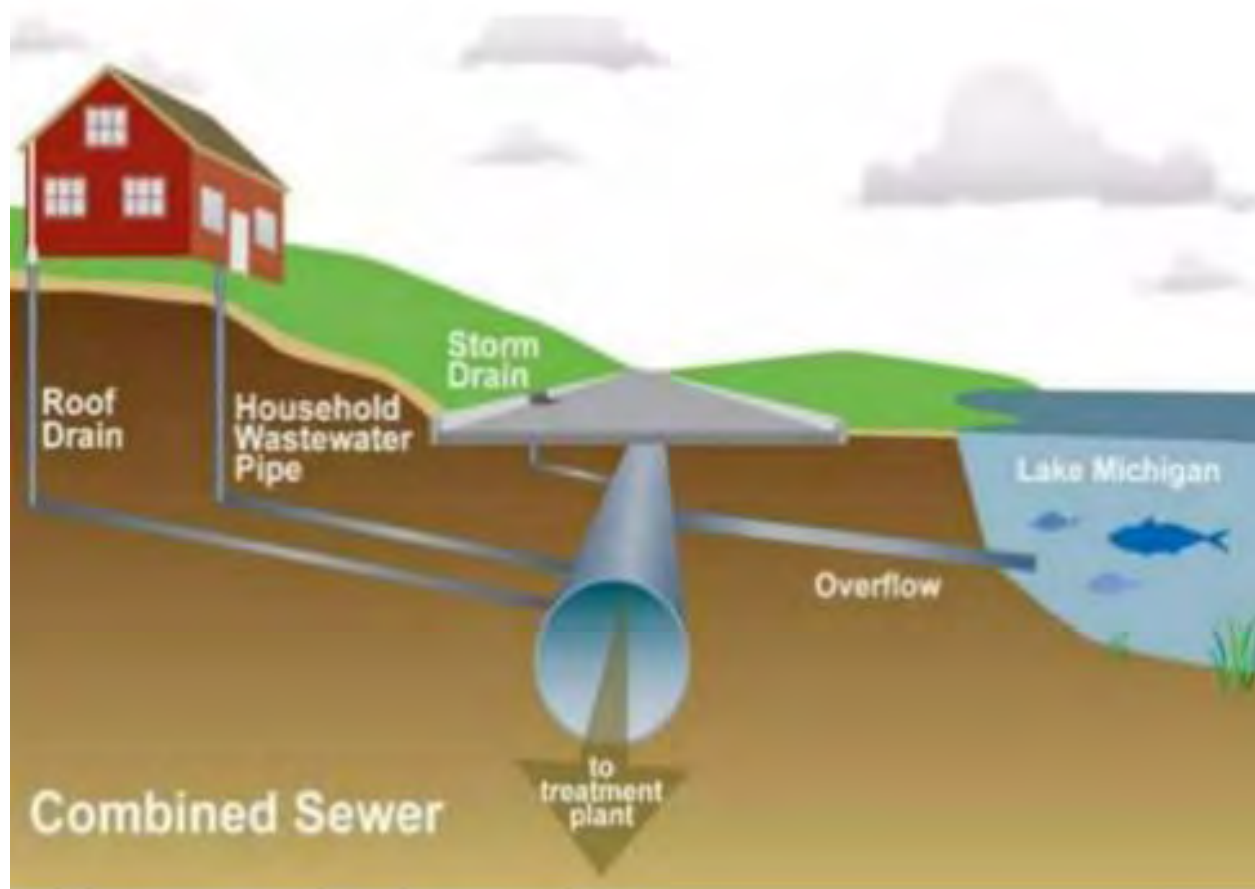

# Outdoor water Use Reduction

## Large Underground Tank



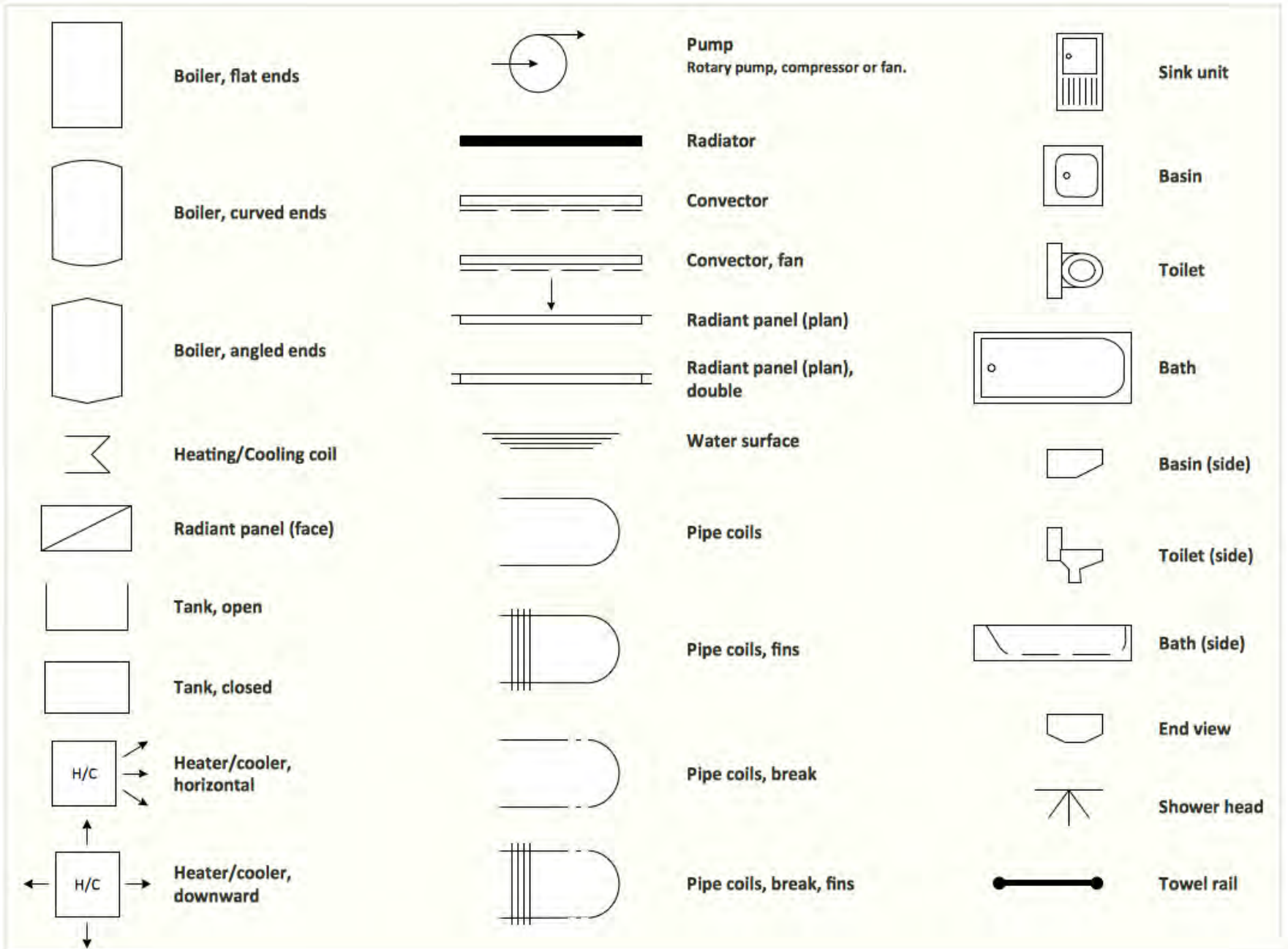

# SANITARY APPLIANCES

## Roof drainage

Rainwater running off both pitched and flat roofs is usually collected by gutters and outlets and discharged by rainwater downpipes to drains, sewers or soakaways

## Flat roofs

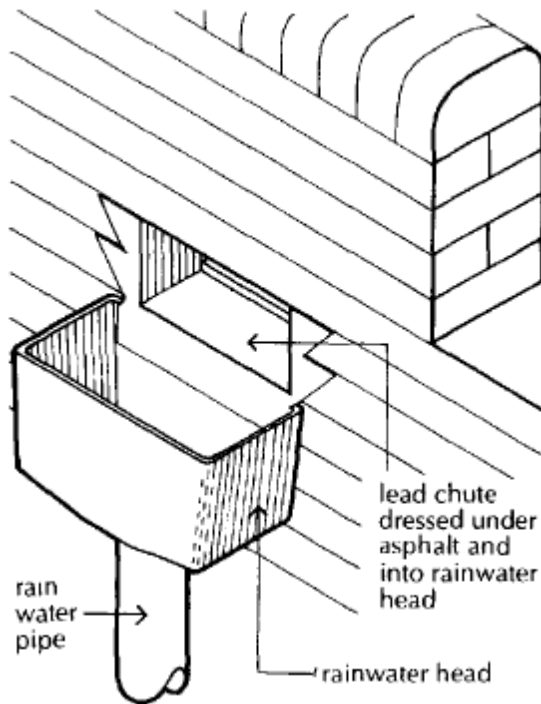

Flat roofs should be laid to a shallow fall towards outlets to avoid what is termed 'ponding'. Ponding is caused by too shallow a fall or the inevitable deflection under load of any horizontal structure that will cause water to lie on a flat roof in the form of a shallow pond. The static ponded water will accelerate deterioration of most flat roof coverings and will penetrate cracks caused by thermal and moisture movements of the structure

# Roof drainage

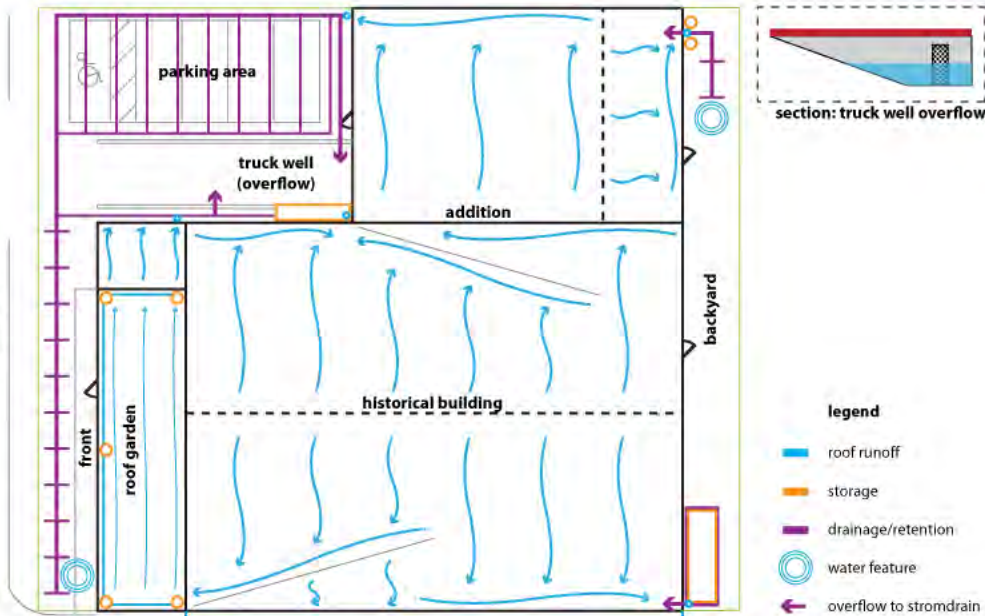
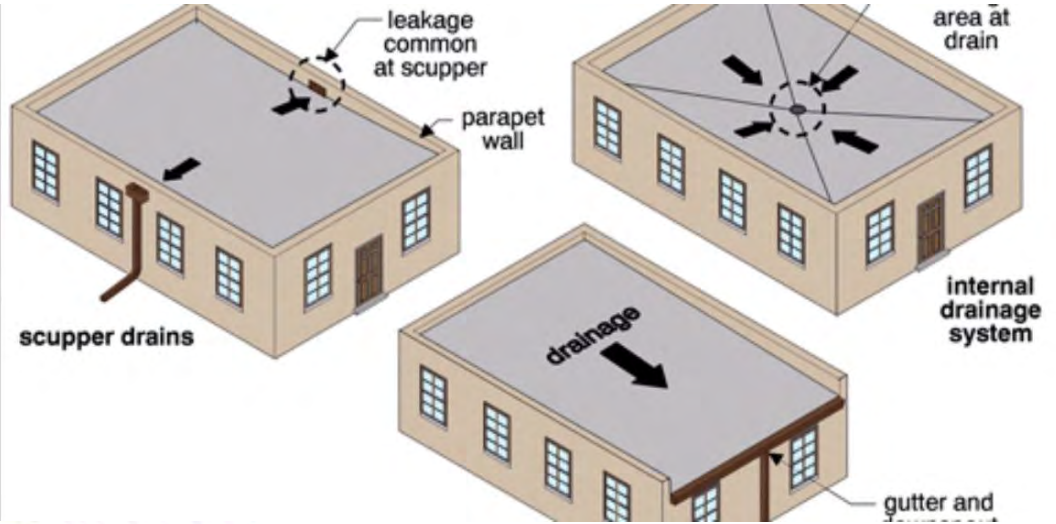
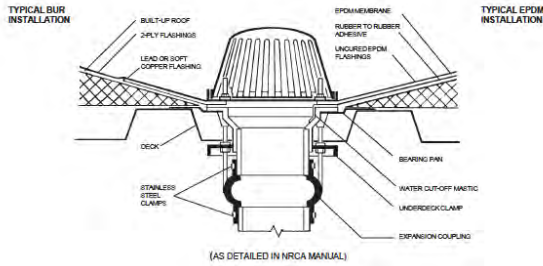

Natural Water System - Drainage and Harvesting

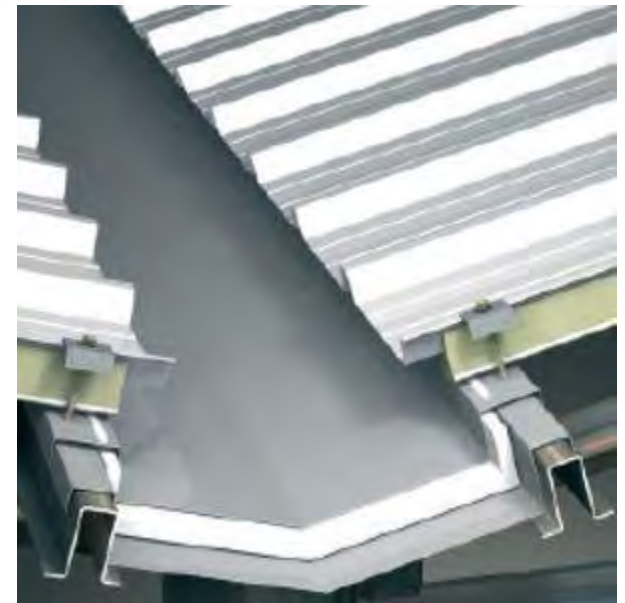
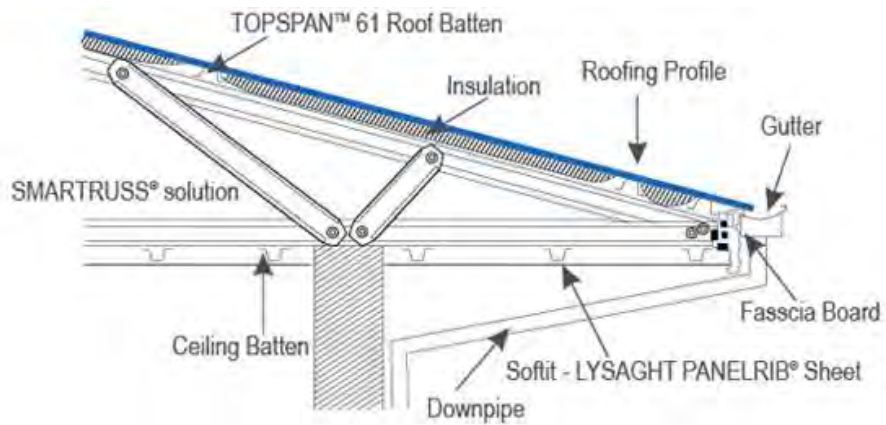
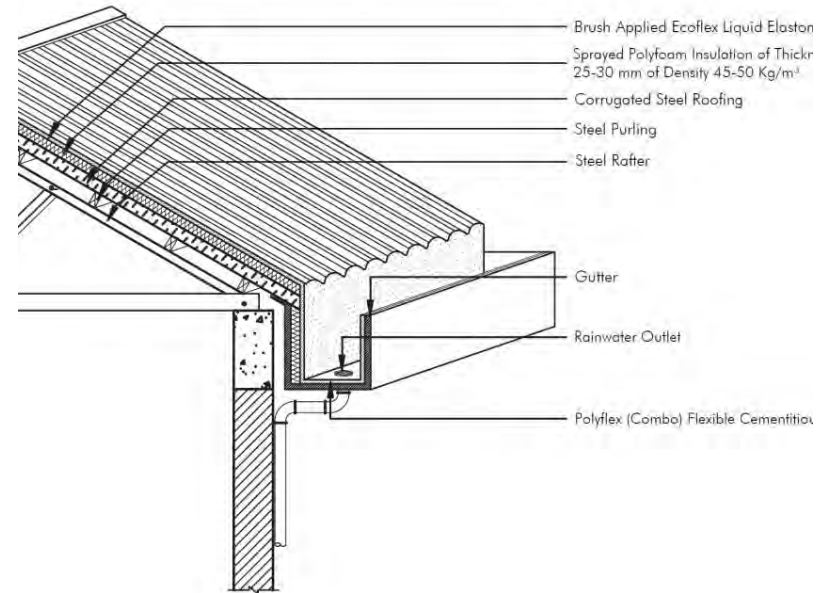
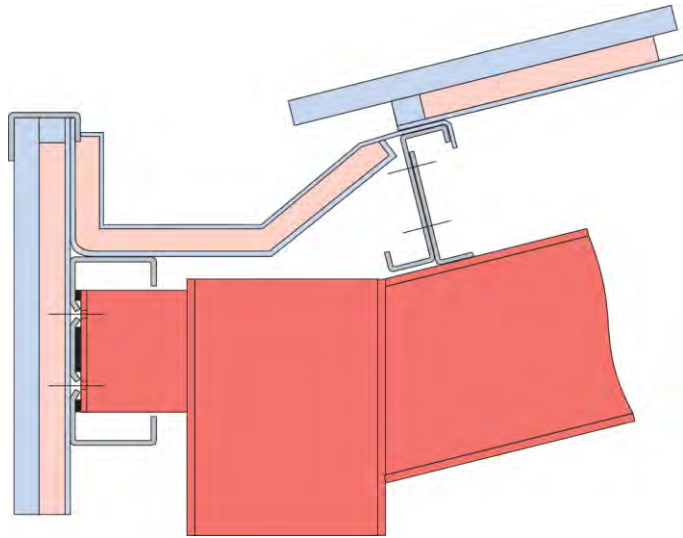



## What's the Minimum Roof Slope To Accommodate Rainwater Drainage?

According to the International Building Code, a minimum slope of  $\frac{1}{4}$ " for 1 foot of roof is necessary for proper rainwater drainage for a flat roof. However, areas that receive large amounts of rainfall should have a steeper slope like 1-inch for 1 foot of roof or more.

For flat roofs, the minimum recommended roof slope is  $\frac{1}{8}$ " per 1 foot to accommodate rainwater drainage. As a ratio, it would be 0.125:12, or 0.125 inches slope per 12 inches.

However, the minimum slope as per the International Building Code for standard flat roofs made from asphalt or tar is  $\frac{1}{4}$ " per 1 foot. Or in ratio terms, 0.25:12, or 0.25 inches of slope per 12 inches.

Despite how it may sound, both of these slopes are quite low and are usually not enough for proper rainwater drainage. The minimum recommended roof slope as per the International Building Code is only 1.19-degrees steep.

Generally, a standard flat roof made from common roof materials should have a slope of around 2:12, which means a slope of 2 inches per 12 inches (1 foot). But there are still many factors that play a role in determining the ideal roof slope for your flat roof.

# Factors Affecting Minimum Roof Slope Requirement

## Climate and Location

The climate of your location significantly impacts how effective a roof slope will be at draining rainwater. Some areas that receive multiple episodes of heavy rainfall and snow need a steeper roof slope for proper drainage.

## Roofing Material

The material that your roof is made out of can impact the minimum recommended roof slope for a flat roof. An important objective when creating a roof slope on a flat roof is to prevent rainwater from accumulating on the roof for more than 48 hours. After this time, water starts to damage the roof material, and over time can erode it, causing the roof to leak.

## Drainage Systems

While selecting the roof slope, you must also consider which type of drainage system you are going to be installing in your roof. Different drainage systems have different requirements, both before installation and after regarding maintenance.

If you're selecting a more efficient drainage system, building a steeply sloping roof wouldn't be necessary. Since most of the water will drain on its own, you won't need to depend on the slope to remove all the water from the roof for you.

# SURFACE WATER DRAINAGE

## Paved areas

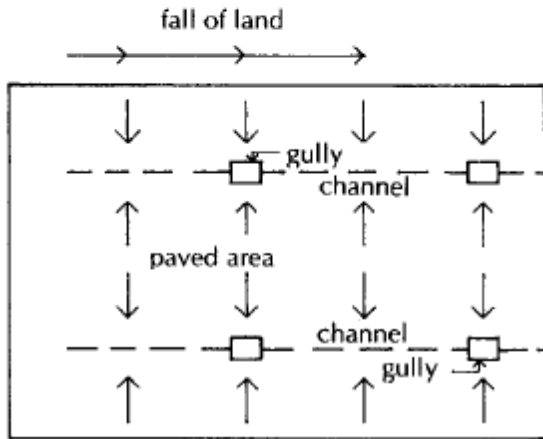

External surfaces that are paved with concrete, natural or artificial paving slabs, bricks or granite sets, should be laid with slight slopes or falls to gullies or channels. The purpose of the falls or slopes to drains is to discharge rainwater reasonably quickly for the convenience of people and to prevent ponding of water that would accelerate deterioration of paving materials by saturation and the effect of frost on water lying in fissures in the material. The slope or fall of paved areas should be sufficient to drain water to outlets, yet not so steep as to make the surface slippery in wet or frosty weather. A minimum fall of 1:60 is generally recommended for paved areas on flat ground.



# Surface Drains

- Cheap arrangement for collecting storm water.

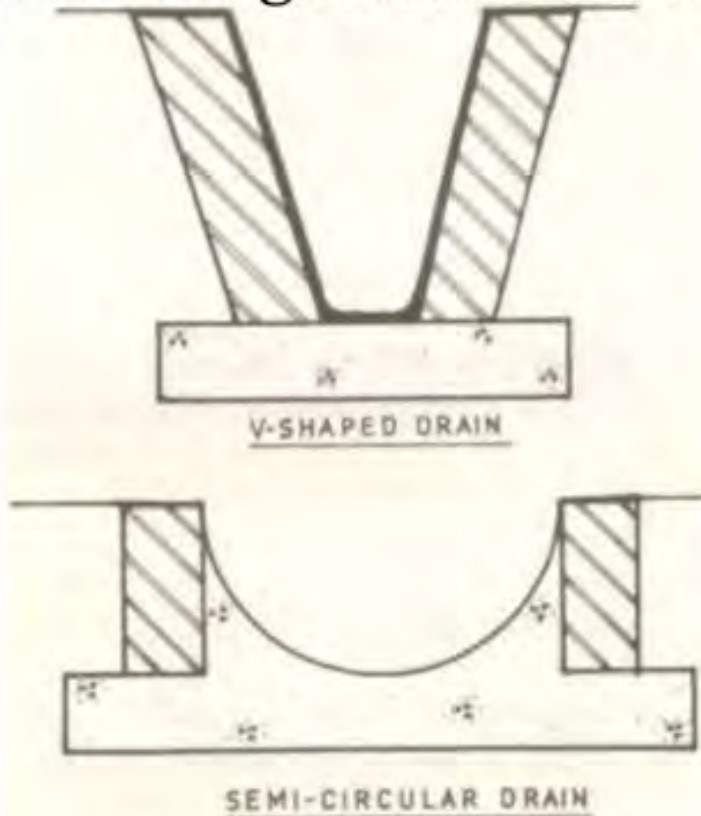

Fig. 21.4 Shapes of surface drains.

