

**University of Salahaddin
College of Engineering
Department of Architecture**



Surgical Department

**Supervised by
Dr. Muhannad G. Rassam
M.Sc. Nazik Jamal
2022-2023**

Surgical Department

Surgical Department

In the surgical department, treatment is given to the patients whose conditions have been diagnosed but cannot be cured solely with medication.

It should be close to:-

- The intensive care department,
- The recovery room and
- The central sterilization area because there is extensive interaction between these departments and so easy access must be assured.

Surgical unit must be isolated from the rest of the hospital operations. This is achieved by a demarcation system using lobbies .

Surgical departments are best located centrally in the core area of the hospital where they are easy to reach.

The reception area for emergency cases must be as close as possible to the surgical area since such patients often need to be moved into surgery immediately.

Renewal of the surgery department of the Academic Medical Center (AMC), Amsterdam, the Netherlands, Valtos Architecten, 2008-2015. Daylight is provided from above via a skylight.

Circle Bath, Bath, UK, Foster + Partners, 2009. Operating room with daylight



Surgical Department

Organization of the surgery department

Every surgical department requires the following rooms:-

Operating theatre	40-48 m ²
Entry room	15-20 m ²
Exit room	15-20 m ²
Washroom	12-15 m ²
Equipment room	10-15 m ²

In new projects, it is permissible for two operating theatres to share the same exit room.

Essential to surgical departments are a staff lobby, patient lobby, clean work corridor, anesthetic workroom, waste lobby, supply lobby, standing area for two operating trolleys and, nearby, the recovery room.

The patient demarcation lobbies are also used for bed to- bed transfer, preparation of operating tables and ward beds, and theatre stores. An appropriate size is around 36 m² and fittings should include wash-basins and an electric conveyor for bed-to-bed transfer.



Ziekenhuis Lievensberg, Bergen op Zoom, the Netherlands, De Jong Gortemaker Algra, 2009. Operating room

Surgical Department

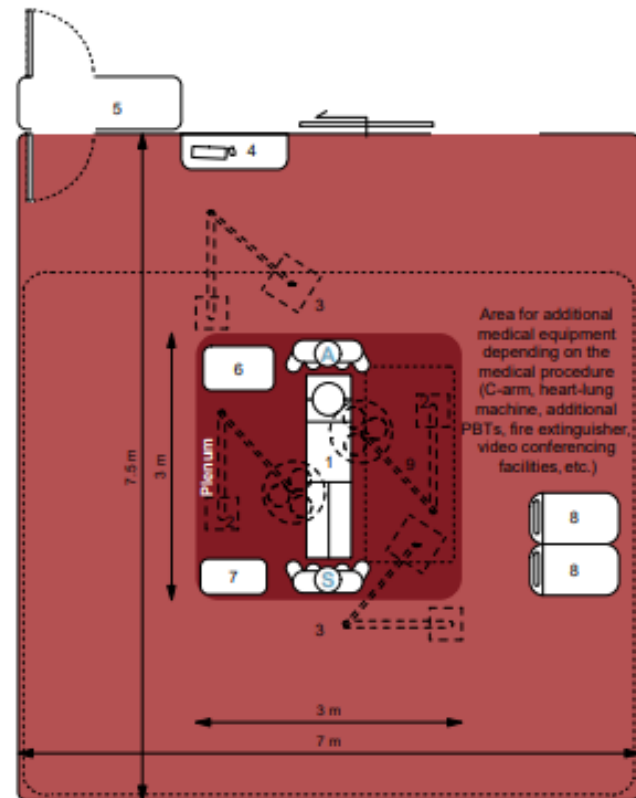

- Operating Room
- 1 Operating table
 - 2 Adjustable surgical lights
 - 3 Surgical pendant
 - 4 Medical PC with medical keyboard, phone (both wall mounted to avoid surfaces for dust accumulation)
 - 5 Interlock system for movement of goods (and, sometimes, people) during the procedure
 - 6 Anesthesia trolley
 - 7 Instruments table
 - 8 Procedure-based trolley
 - 9 Inpatient bed (present during transfer to and from the OR, before and after the procedure)

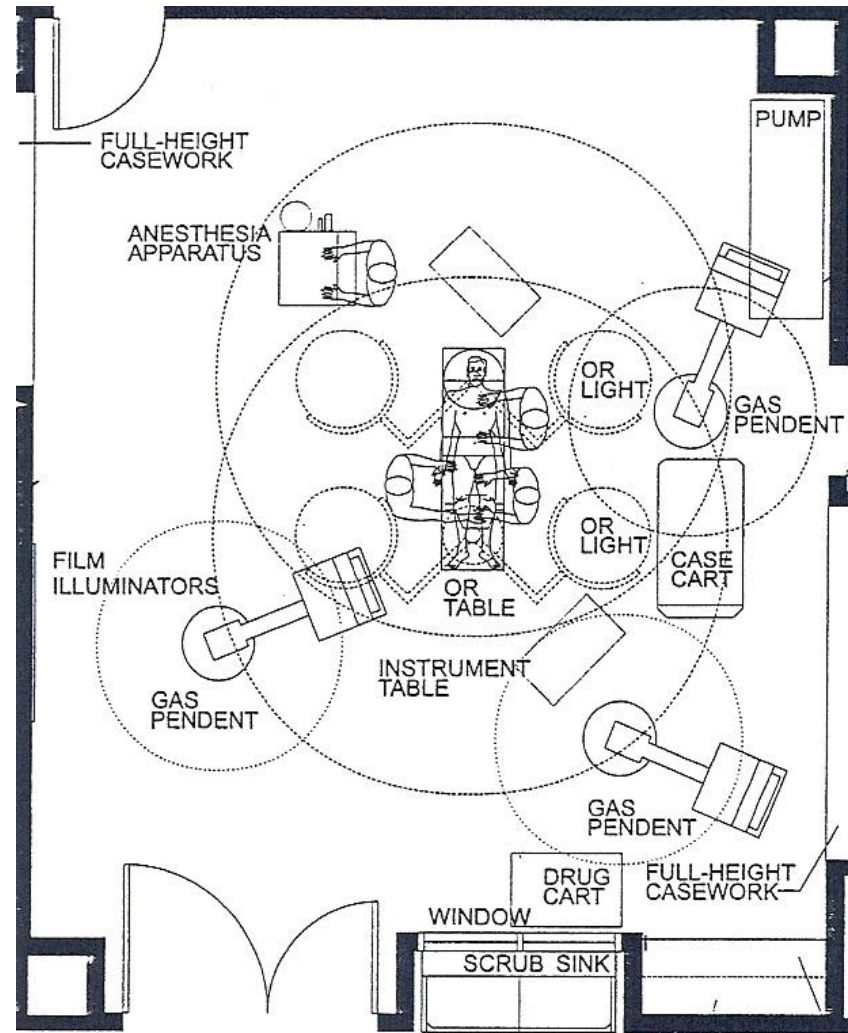

Surgical Department

Floor plan of surgical area with a direct link to the main building.

The corridor system is separated into staff corridors with links to the functional rooms and pre-operative and post-operative patient corridors.

A requirement when planning a new building is that it must be expandable on at least one side.

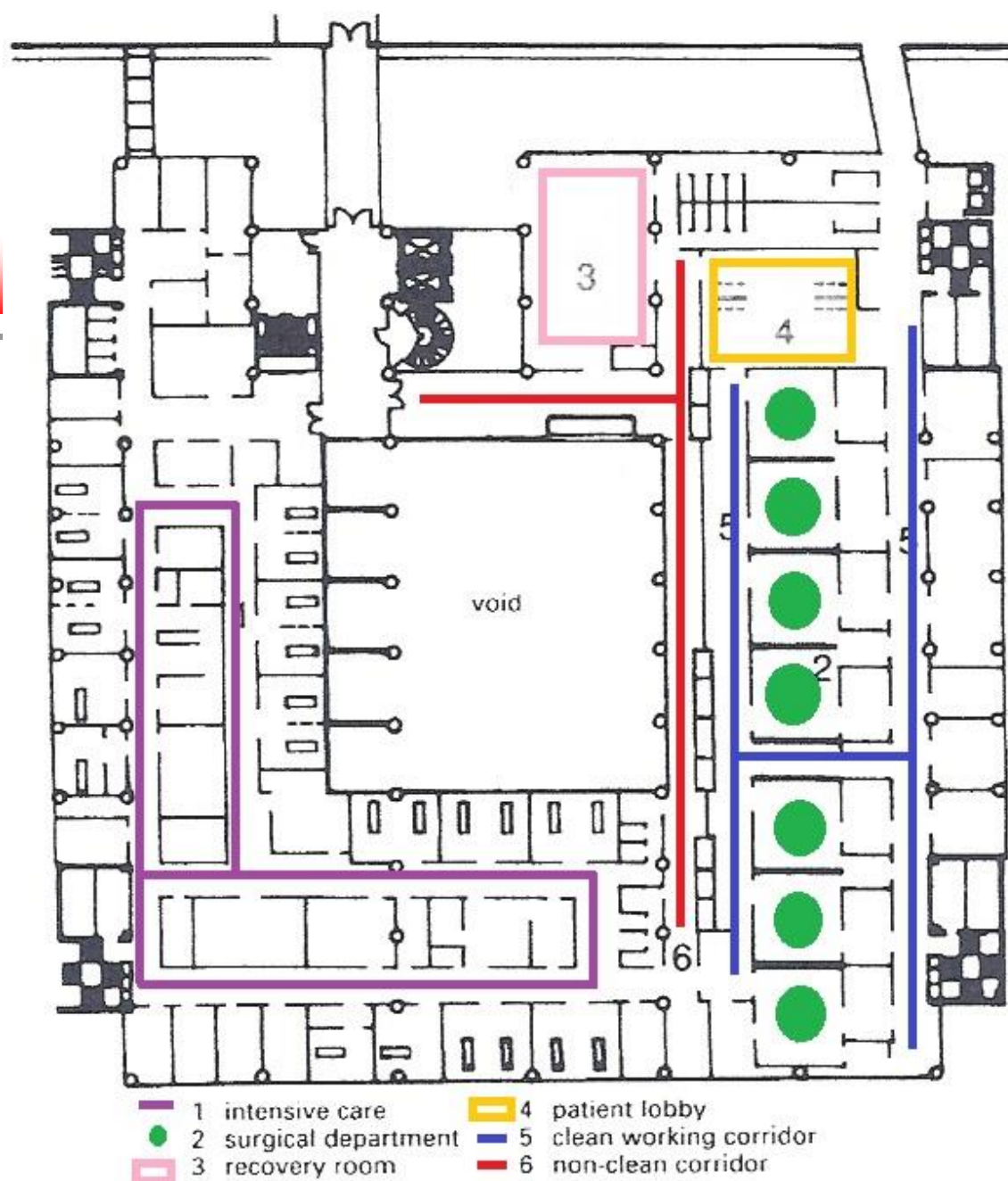

①

**Surgical operations centre, Katharinen Hospital, Stuttgart:
second floor**

Architects: Heinle, Wischer and Partners.

Surgical Department

Floor plan of the central operating area at the Northern Hospital Centre, Dortmund, with five operating theatres and additional rooms.

Pre-operative and post-operative patients are separated and the staff circulate via the area accommodating non-anesthetic patients area.

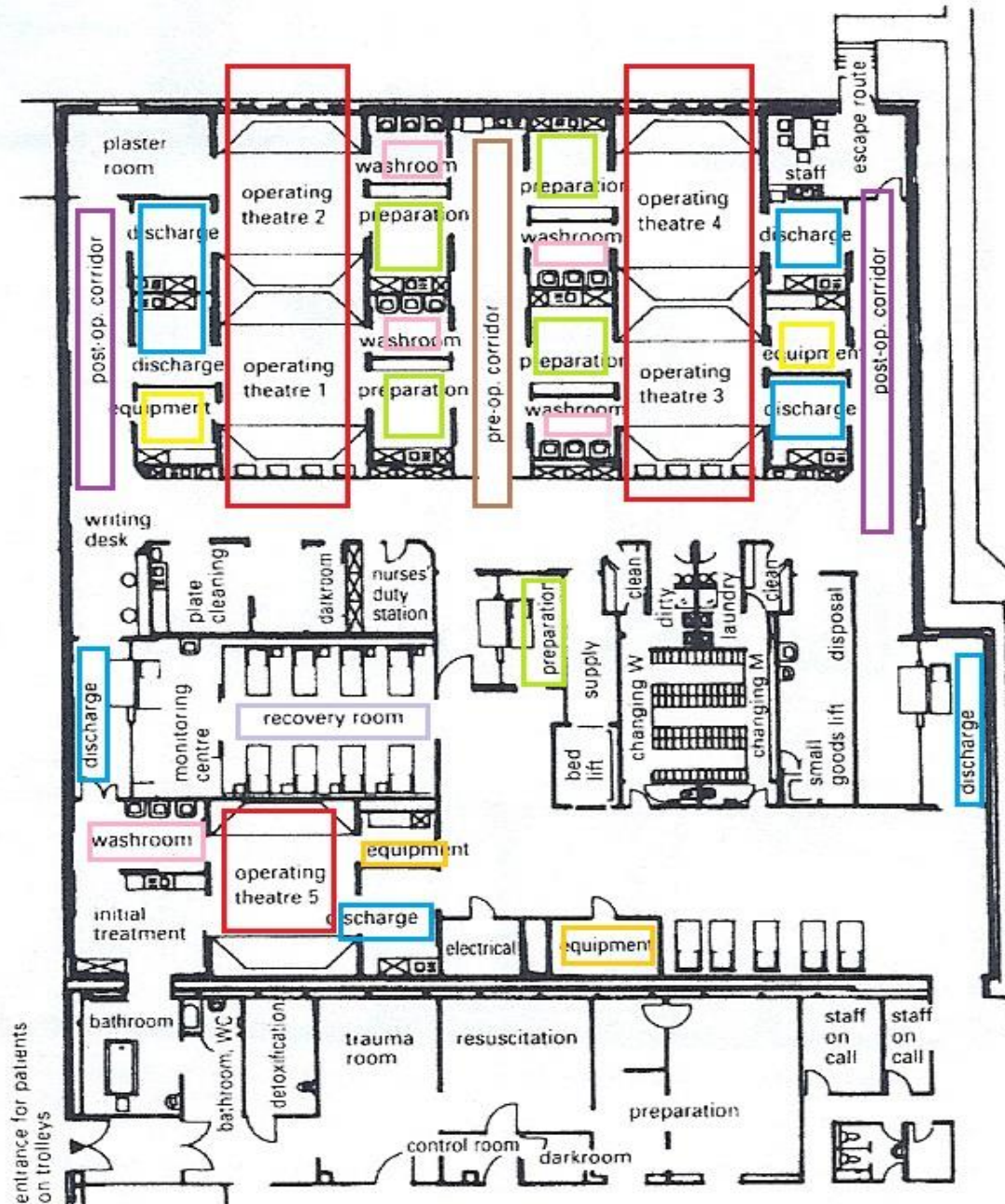

2 Ground plan of central surgical area Architects: Heinle, Wischer and Partners

Surgical Department

Main Surgical Rooms

The operating theatre should be designed to be as square as possible to allow working whatever direction the operating table is turned in.

A suitable size would be 6.50 x 6.50 m, with a clear height of 3.00 m and an extra height allowance of roughly 0.70m for air conditioning and other services.

It is important to isolate the highly sterile areas to which sterile instruments are supplied.

Division of the operating theatres into septic and aseptic zones is a matter of medical controversy, but is a sensible precaution.

Floors and walls must be smooth throughout and easily washed; decorative or structural projections should be avoided.

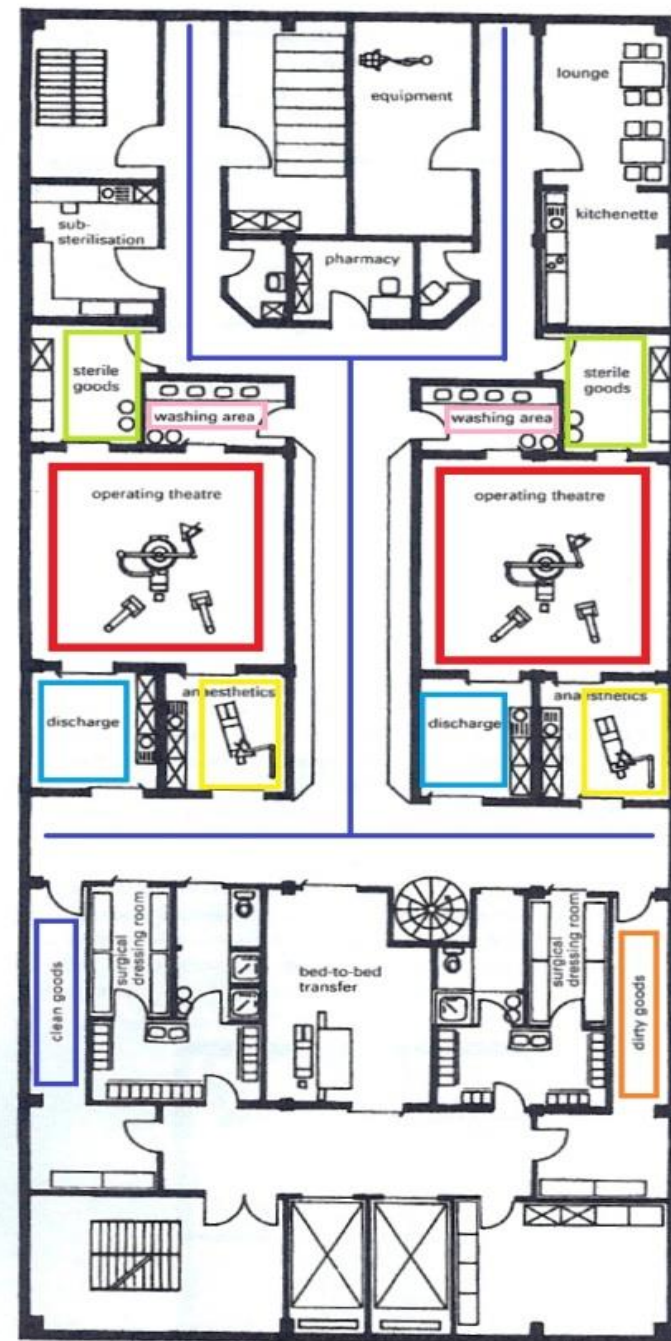

Ground floor plan of a surgical annex with underground link to the main building: recovery room one floor below



Surgical Department

Anesthetics room

The anesthetics room should be approximately 3.80 x 3.80 m in size and have electric sliding doors into the operating theatre (clear width 1.40m). These doors must have windows to give a visual link with the operating theatre.

Anesthetic discharge room

This is set out identically to the anesthetics room. The door to the working corridor should be designed as a swing door with a clear width of 1.25 m.

Washroom

Division into clean and non-clean washrooms is ideal, a single large room is adequate. The minimum width of the room should be 1.80m.

For each operating theatre there should be three non-splash wash-basins with foot controls. Doors into the operating theatre must have an inspection window and, if they are electrical, be opened by foot controls.



Surgical Department

Sterile goods room

The size of this room is more flexible and it must be accessed directly from the operating theatre. One room of roughly 10 m² is required per operating theatre .

Equipment room

Although direct access to the operating theatre is preferable, it is not always feasible the equipment room must be located as close as possible to the theatre in order to reduce waiting times. A room size of approximately 20m² should be allowed.

Sub sterilization room

This room may or may not be connected directly to the operating theatre's sterile area. It contains a non-clean area for non-sterile material and a clean area for prepared sterile items. Linking a sub sterilization room to several operating theatres causes hygiene problems and so should be avoided. Note that surgical instruments are prepared in the central sterilizing unit, which lies outside the surgical area.

Plaster room

For hygiene reasons this is not located in the surgical zone but in the outpatient area. In emergencies the patient must be channeled through lobbies in order to get to the operating theatre.

Surgical Department

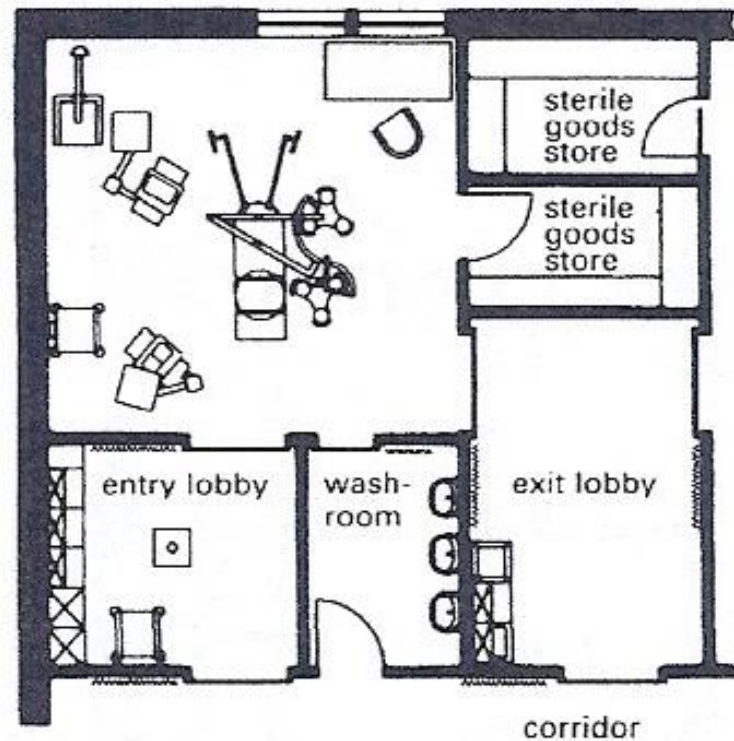
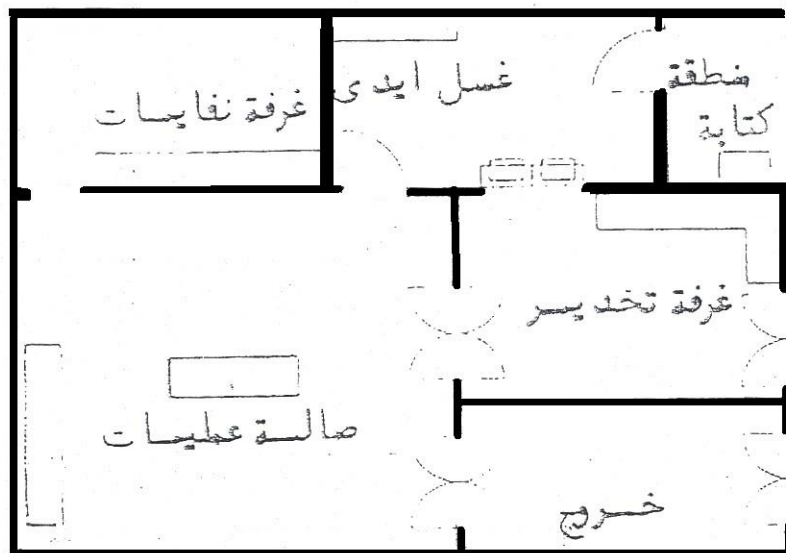

③ Arrangement of an operating theatre with adjacent rooms

Architects: U + A Weicken



Surgical Department

Recovery room requirements

The recovery room must accommodate the post-operative patients from more than one operating theatre. The number of beds required is calculated as 1.5 times the number of operating theatres. Designs should allow in daylight to help the patients to orientate themselves.

Dictation room

No larger than 5 m² in size, such rooms are where the doctors prepare reports following an operation.

Pharmacy

A 20 m² pharmacy can supply a combination of anesthetics and surgical medication and other materials.

Cleaning room

A size of 5 m² is sufficient for cleaning rooms. They should be close to the operating theatre since cleaning and disinfection are carried out after each operation.

- 1 Operating room
- 2 Instruments preparation room
- 3 Holding area
- 4 Recovery area
- 5 Supervising nurse's desk (moveable)
- 6 Planning and coordination office
- 7 Sluice
- 8 Staff changing rooms
- 9 Staff rest area
- 10 Satellite pathology laboratory and sample collection for other labs
- 11 Temporary storage for (medical) waste
- 12 Temporary storage for used instruments
- 13 Waiting area for accompanying persons
- 14 Storage area for sterile instruments and disposables and other sterile materials
- 15 Storage area for clean linen and other clean, non-sterile materials

- I Patient in
- II Patient out
- III Acute and trauma patients
- IV Persons accompanying patients
- V Medical staff
- VI Sterile instruments, disposables and materials, clean linen and materials
- VII Waste disposal
- VIII Instruments sterilization and laundry services
- IX Samples for lab analyses

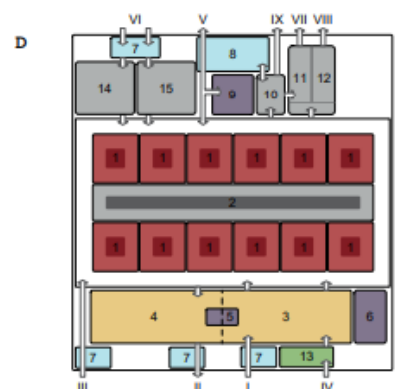
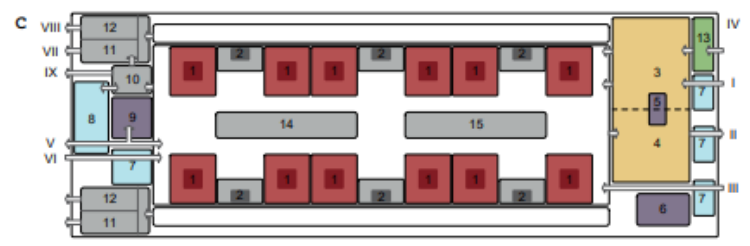
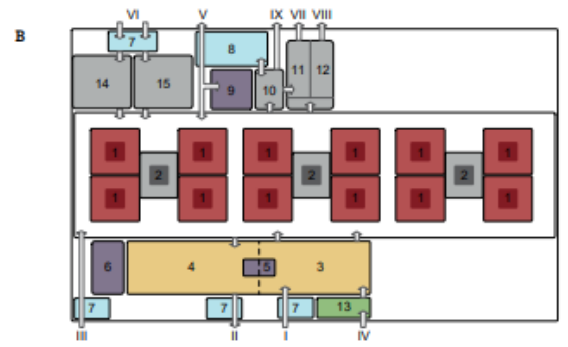
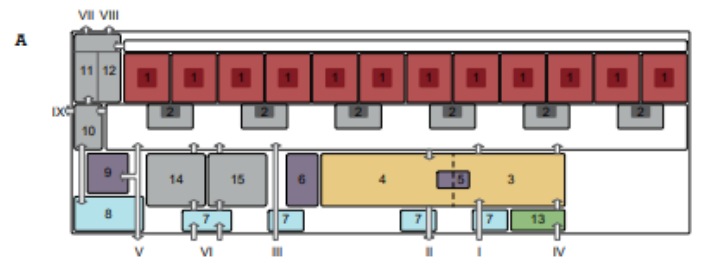

Operating department layout models and traffic routes

- A Single corridor model
- B Cluster model
- C Double-loaded corridor model
- D Clean corridor in the middle

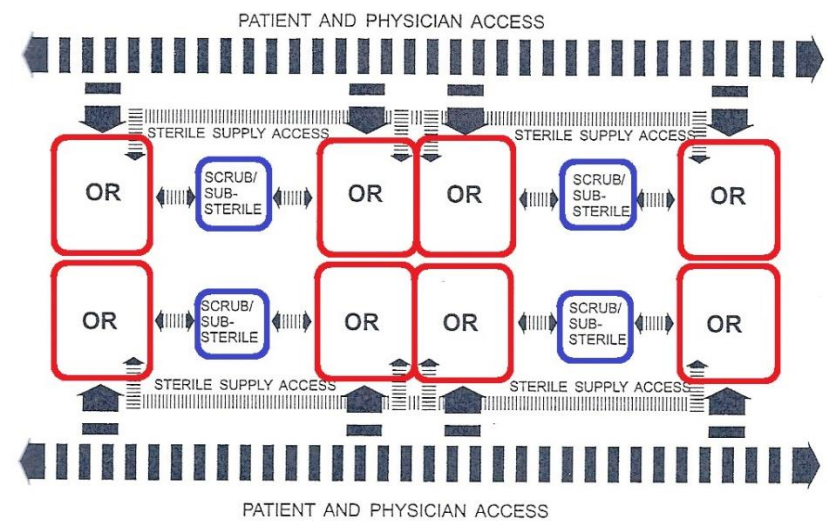
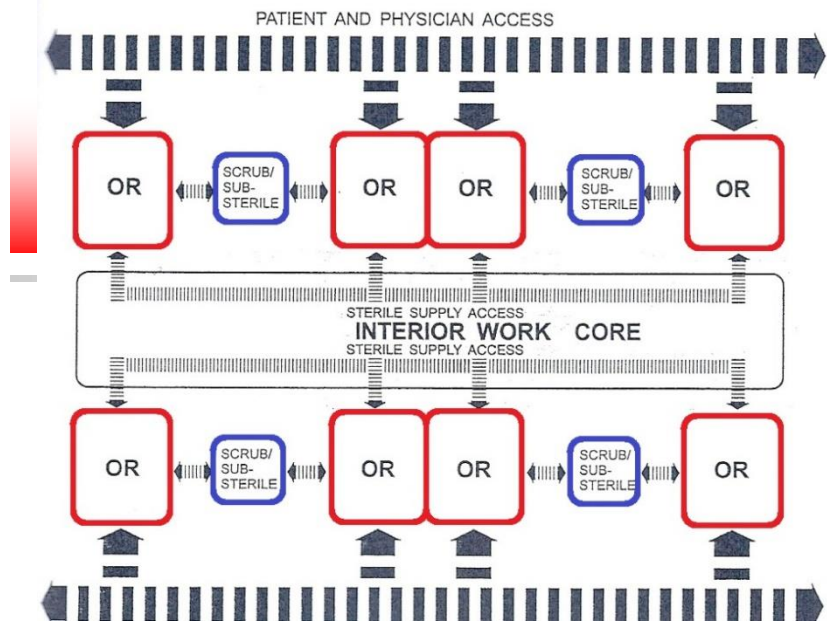

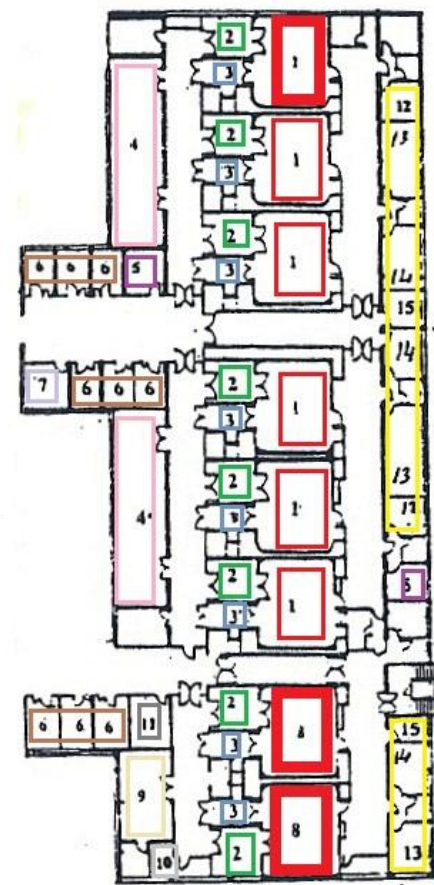
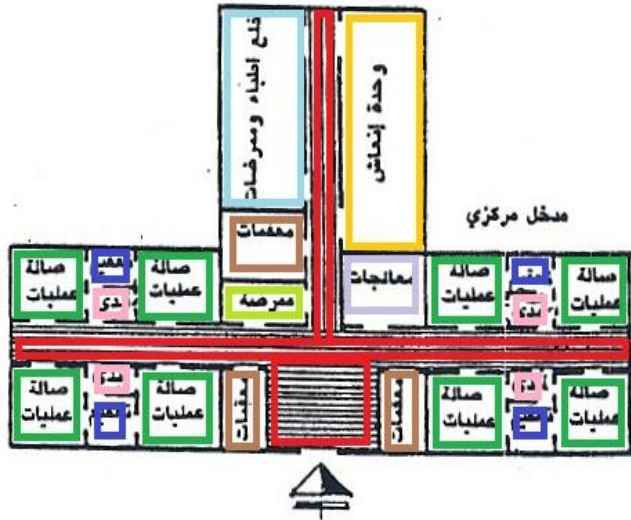

- 1 - صالة عمليات معقمة.
- 2 - حجرة تخدير.
- 3 - خروج مريض.
- 4 - فحص وانتظار قبل التخدير.
- 5 - معمل.
- 6 - عمليات عاجلة.
- 7 - محطة مرضات.
- 8 - صالة عمليات عفة.
- 9 - صالة تجيبس.
- 10 - مخزن أجهزة وأشعة.
- 11 - مكتب الرئيسية.
- 12 - مكتب كبير الجراحين.
- 13 - قلم وراحة مرضات.
- 14 - قلم وراحة أطباء.
- 15 - مكتب إدارة القسم.

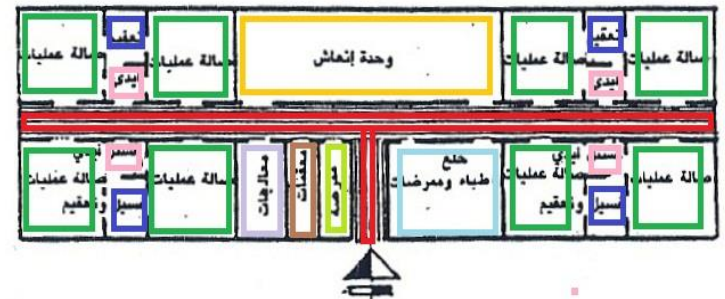
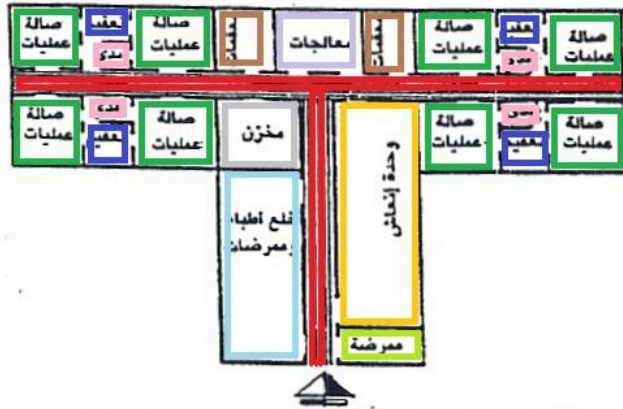

Central Sterilization

Central sterilization

This is where all hospital instruments are prepared. The majority of instruments are used by the surgical department (40%), surgical intensive and internal intensive care (15%).

For this reason central sterilization should be installed close to these specialist areas. It is recommended that the sterilization area be situated in areas with relatively low volumes of traffic (both people and materials).

The number of sterilizers is dependent on the size of the hospital and surgical department, and can occupy an area of approximately 40-120 m².

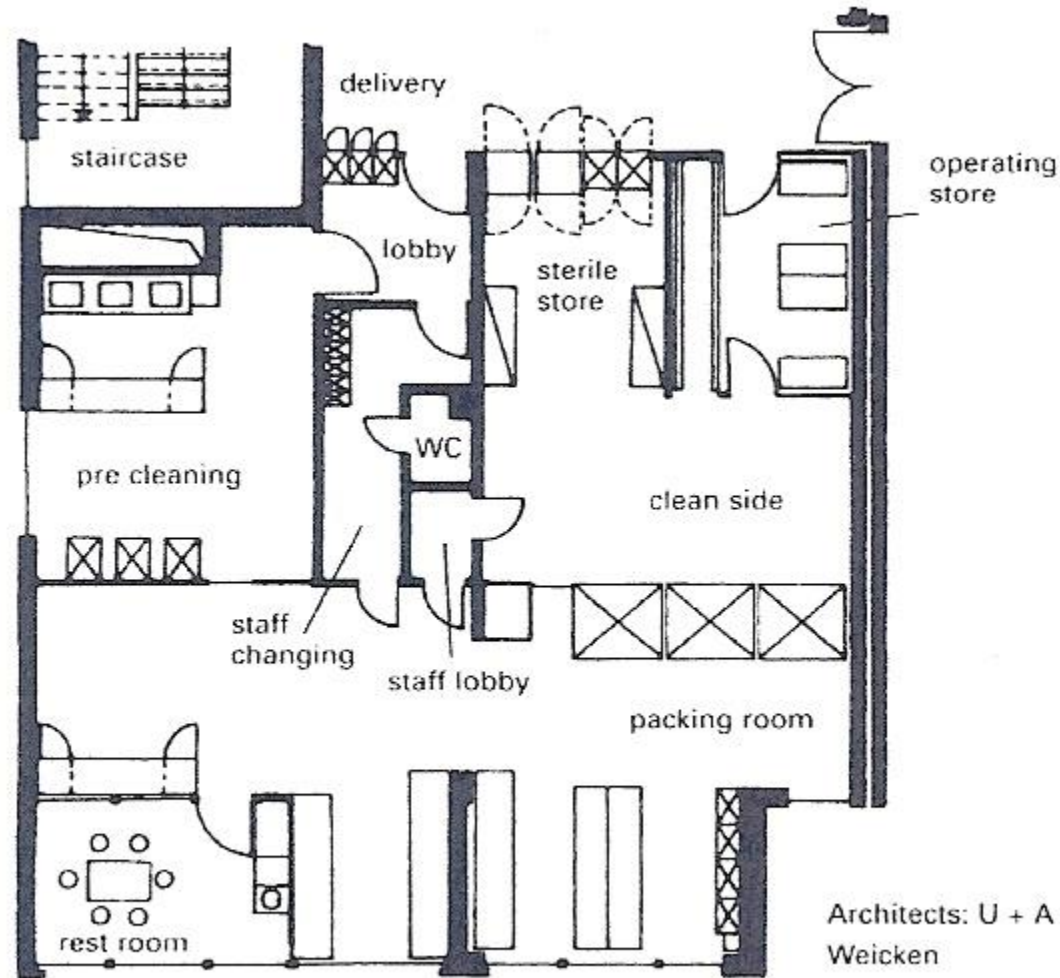

5

Central sterilisation unit, St Elisabeth, Halle/S