

Salahaddin University – Erbil
College of Science
Environmental Health and Science Department
3rd Stage



1st Lecture in Environmental Engineering

Introduction

By: Lecturer Nihal S. Hanna

Email: nihal.hanna@su.edu.krd

2021-2022

Syllabus

1. Basic Principles
2. Geometrical Operation
3. Projection
4. Sectional Views
5. Environmental and Engineering Drawing

Engineering drawing

- ✓ Engineering drawing is a formal and precise way of communicating Information about the shape, size, features and precision of physical objects.
- ✓ Drawing is the universal language of engineering.

Technical Drawing

A technical drawing is a means of clearly and concisely communicating all of the information necessary to transform an idea or a concept in to reality. Therefore, a technical drawing often contains more than just a graphic representation of its subject. It also contains dimensions, notes and specifications.

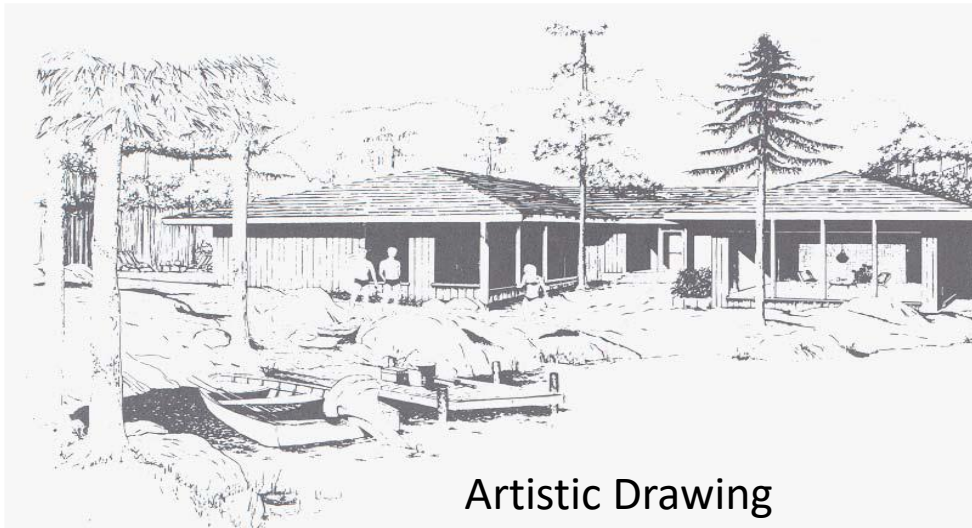

Artistic Drawing

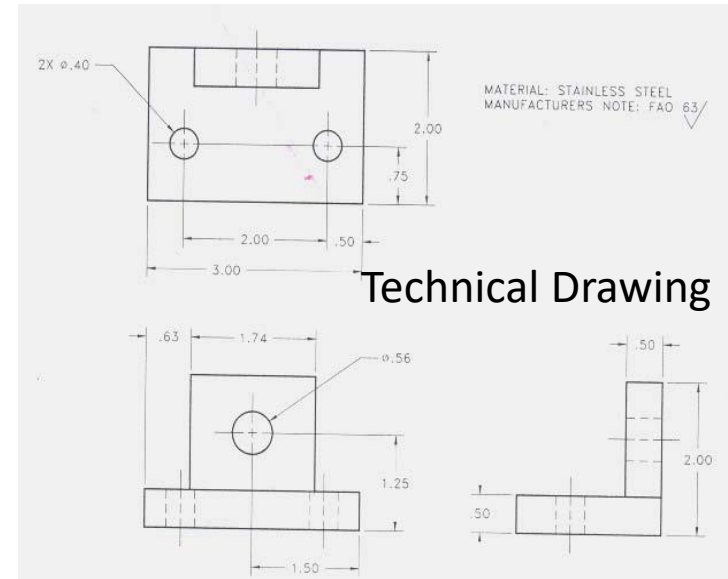

Technical Drawing

Drawing Equipments

The main and important drawing equipment:

1. Drawing Sheets

Symbol	Sheet Dimensions	
A0	(1089 X 841) mm	
A1	(841 X 594) mm	
A2	(594 X 420) mm	
A3	(420 X 297) mm	
A4	(297 X 210) mm	
A5	(210 X 148) mm	

Table1: Description of the size of drawing paper

2. T-SQUARE & TRINGLES



30° and 60° Triangle

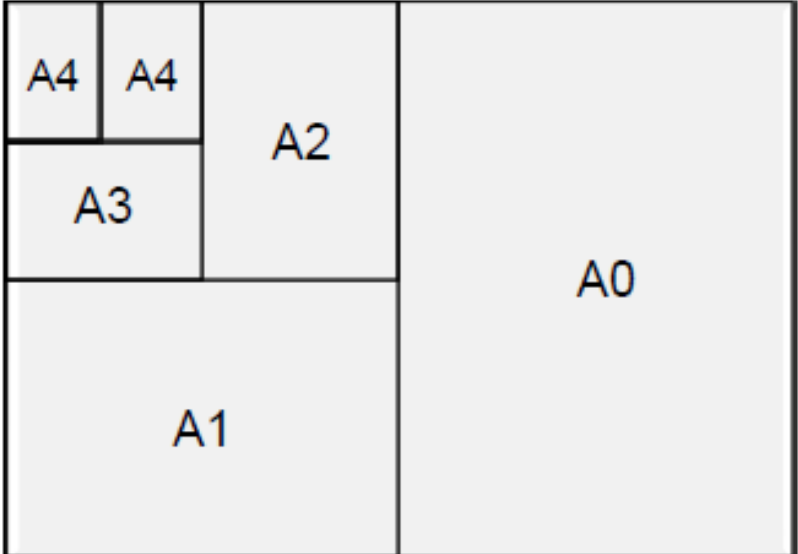
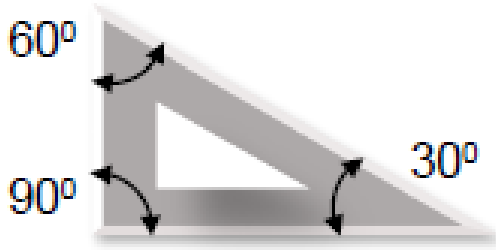
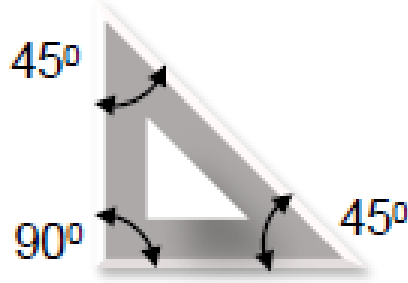

45° Triangle

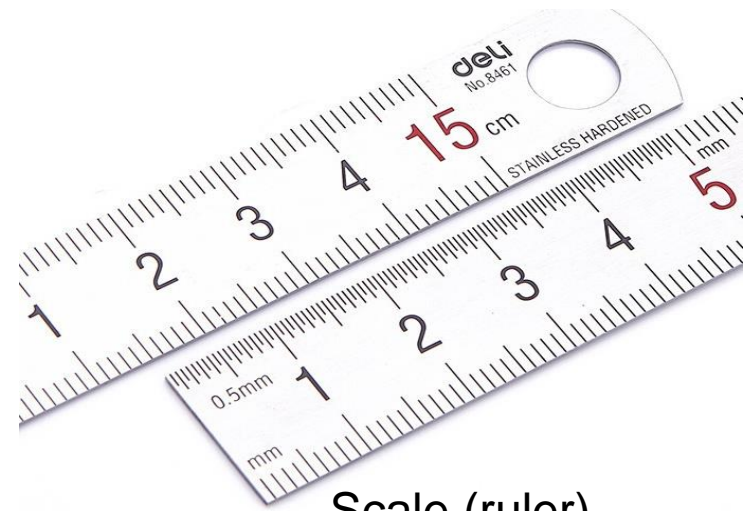

Scale (ruler)

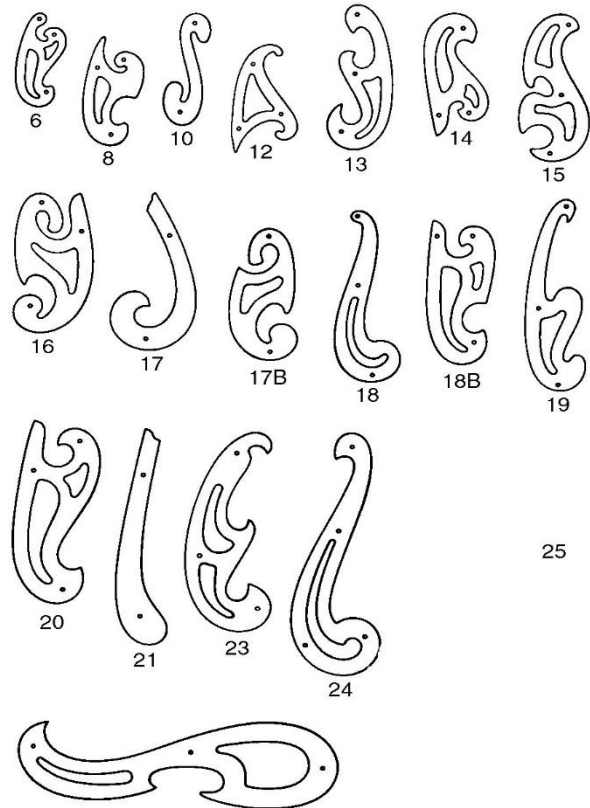

French curves



T - SQUARE

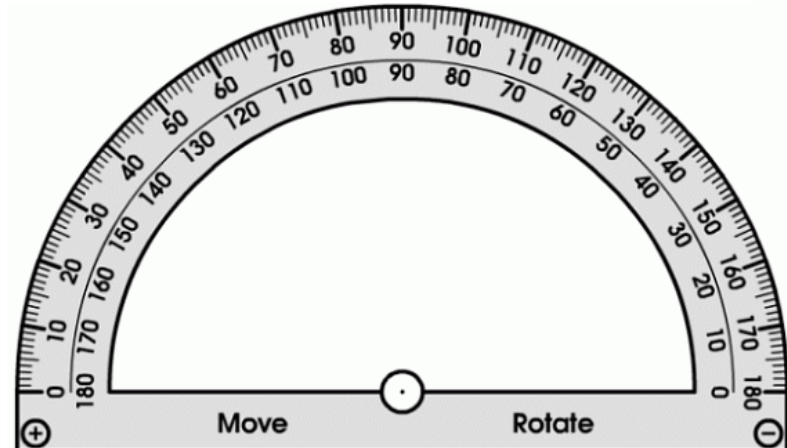

Protractor

3. Divider



4. Pencils And Erasers



WOODEN PENCILS



ERASER



MECHANICAL PENCILS (0.5 OR 0.7) mm



Tapes

International Standard Units

Factor	Name	Symbol	Factor	Name	Symbol
10^1	deka	da	10^{-1}	deci	d
10^2	hecto	h	10^{-2}	centi	c
10^3	kilo	k	10^{-3}	milli	m
10^6	mega	M	10^{-6}	micro	μ
10^9	giga	G	10^{-9}	nano	n
10^{12}	tera	T	10^{-12}	pico	p
10^{15}	peta	P	10^{-15}	femto	f
10^{18}	exa	E	10^{-18}	atto	a
10^{21}	zetta	Z	10^{-21}	zepto	z
10^{24}	yotta	Y	10^{-24}	yocto	y

The End