

Detailed Design Drawing

Lecturer : Sakar Yousif

2022-2023



What is beam and column

- Steel beams are horizontal structural members that resist loads applied laterally to their axis.
- Columns are vertical structural members that transfer compressive loads. It can be used to form the skeleton of a building.

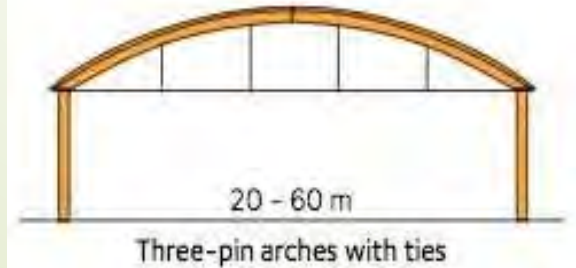
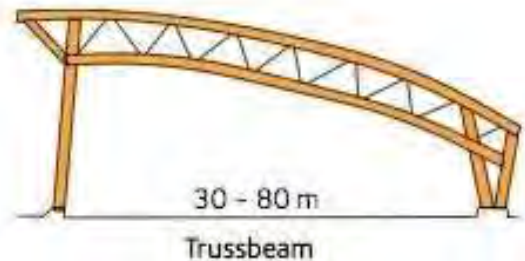
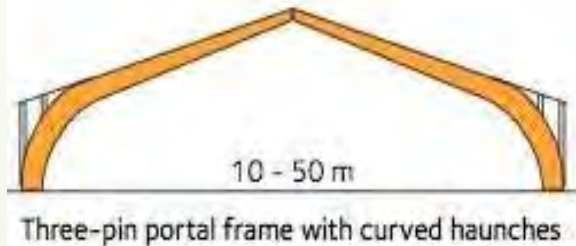
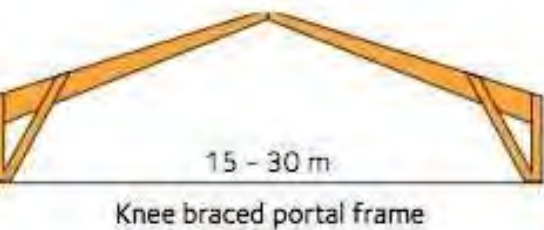
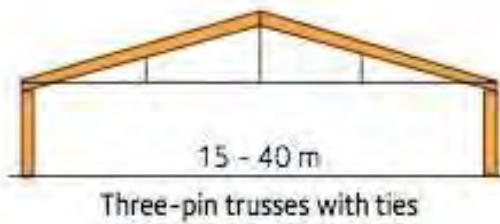
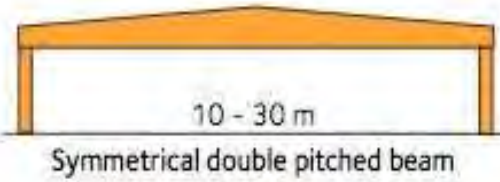
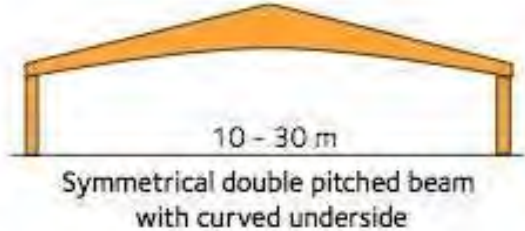
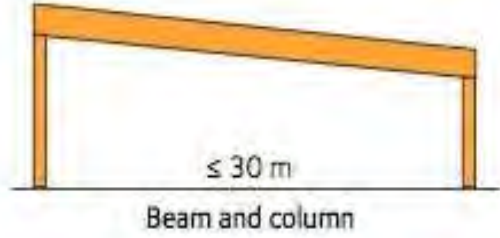
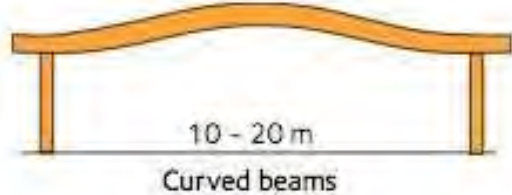

Formes	Portée L (m)	h	H
	8 - 50	L/17	
	10 - 50	L/30	L/15
	5 - 15	L/45	L/10
	10 - 40	L/45	L/20
	10 - 50	L/40	L/17
	20 - 50	L/40	L/20
	10 - 30	L/20	

Different forms of conventional roof trusses and lattice girders



Tapered Column Clear Span (TCCS)

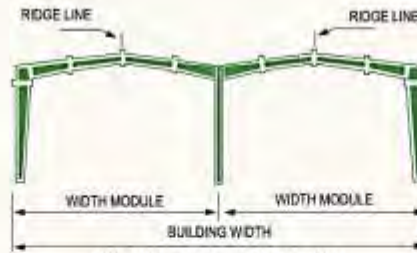

Multi Gable (MG)



Arched Multi Span

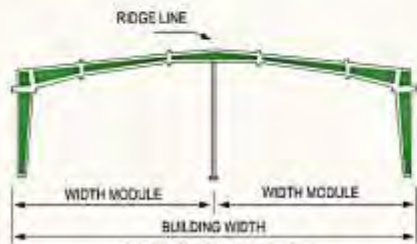

Multi Span "1" (MS-1)

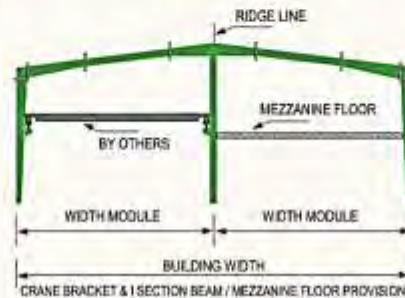

Mono Slope

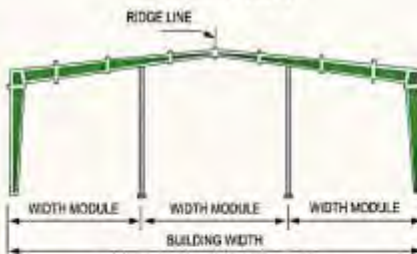

Multi Span "2" (MS-2)

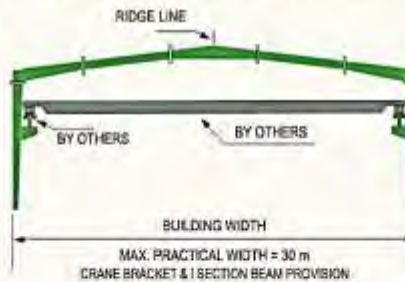

Roof System

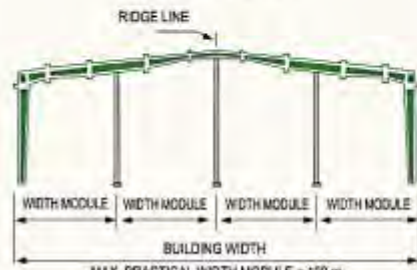

Multi Span "3" (MS-3)

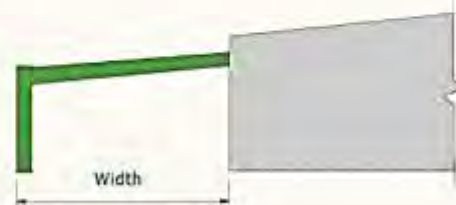

Lean-To

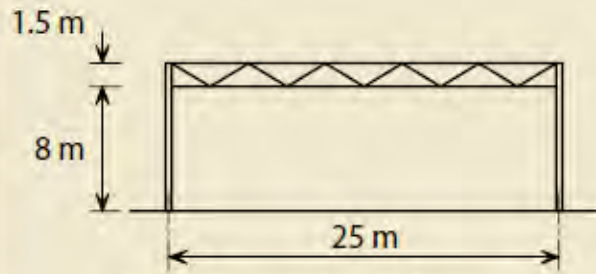

(a) Lattice girder - W form

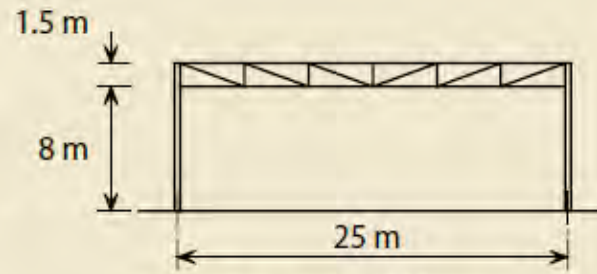

(b) Lattice girder - N form

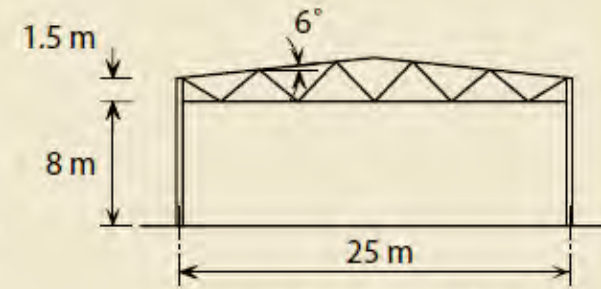

(c) Duo-pitch lattice girder

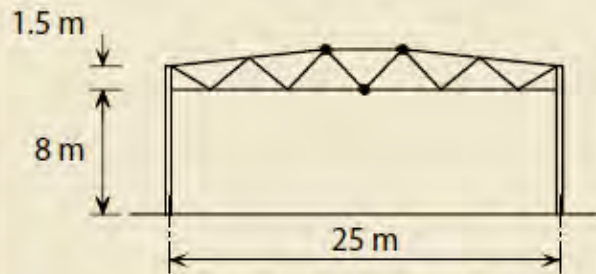

(d) Articulated lattice girder

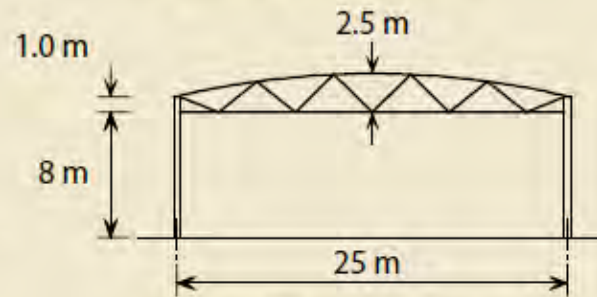

(e) Curved lattice girder

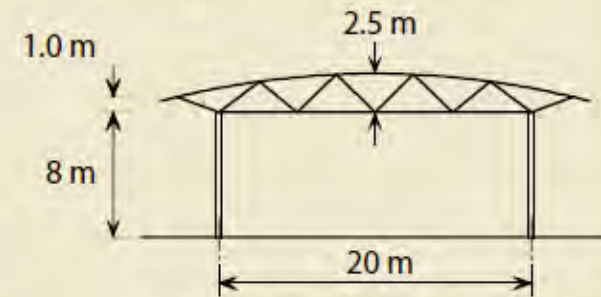

(f) Curved lattice truss and canopy

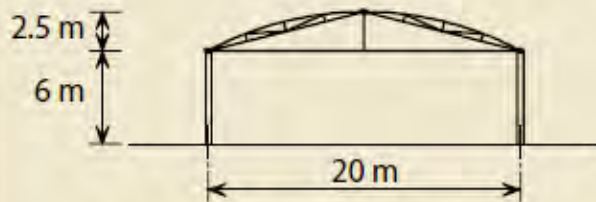

(g) Articulated bow-string

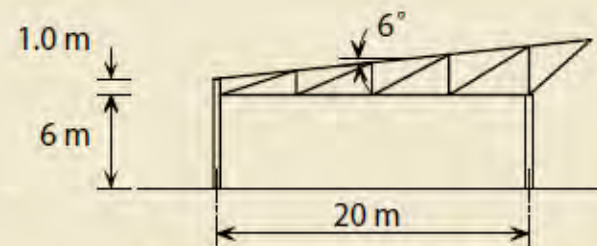

(h) Mono-pitch lattice girder with canopy

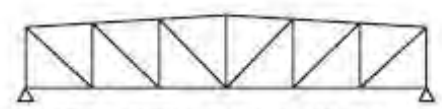
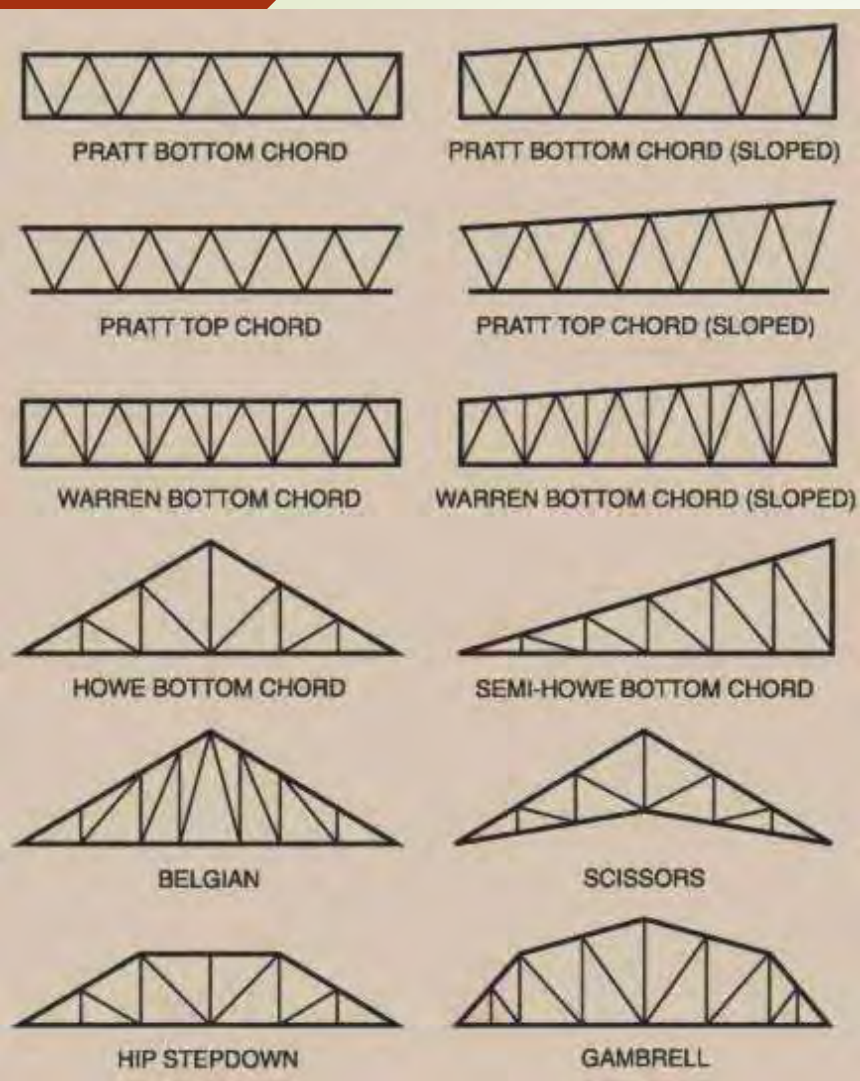

(a) Fitched Pratt truss (spans > 20 m)

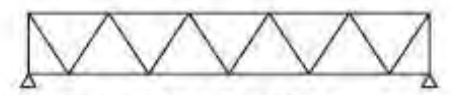

(b) Warren girder (spans > 20 m)

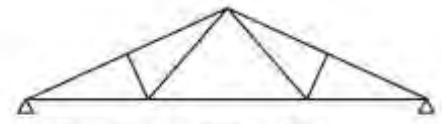

(c) Fink truss (spans up to 10 m)

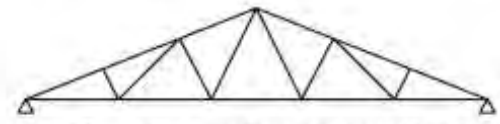

(d) Double Fink truss (spans between 10 and 15 m)

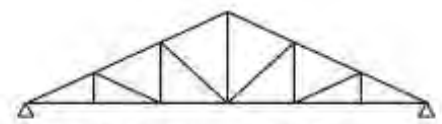

(e) Howe truss (spans up to 15 m)

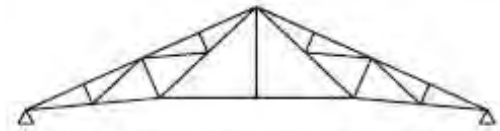

(f) French truss (spans between 12 and 20 m)

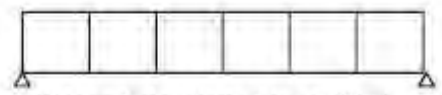

(g) Vierendeel girder (spans up to 20 m)

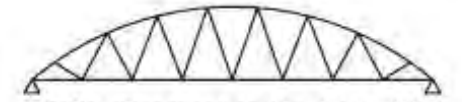

(h) Bowstring truss (very long spans > 30 m)

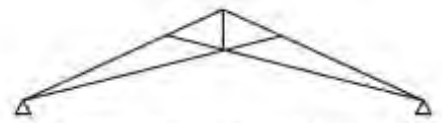

(i) Scissors truss (used to give additional headroom) (spans < 15 m)

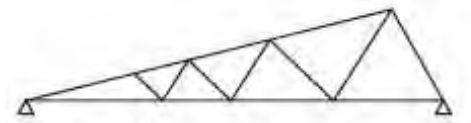

(j) North light truss (spans < 15 m)

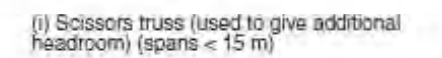

(i) Scissors truss (used to give additional headroom) (spans < 15 m)

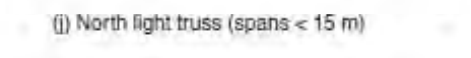

(j) North light truss (spans < 15 m)

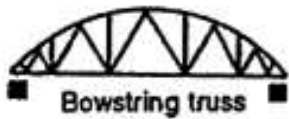

Bowstring truss



Towne lattice truss

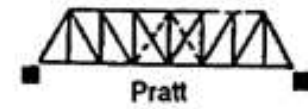

Pratt



Scissors truss



Saw-tooth truss



Camel-back pratt



Pratt truss

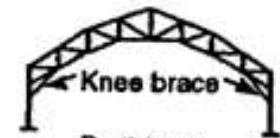

Pratt truss



Modified fink



Truss with monitor



Traverse bent



Pratt (pitch)

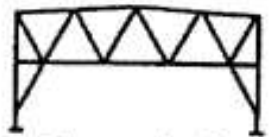

Traverse bent

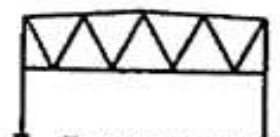

Traverse bent



Fink or French

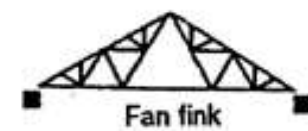

Fan fink

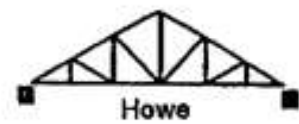

Howe

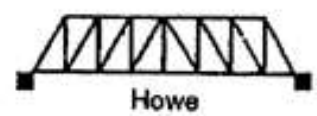

Howe

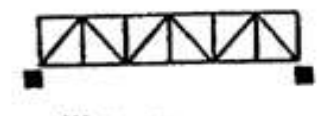

Warren trusses

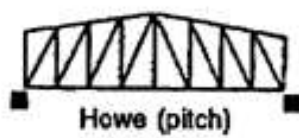

Howe (pitch)

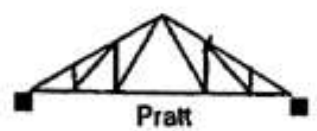

Pratt

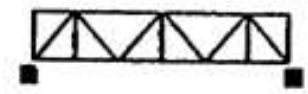



(a) Standard portal (typical span 15 m to 45 m, typical pitch 6°)

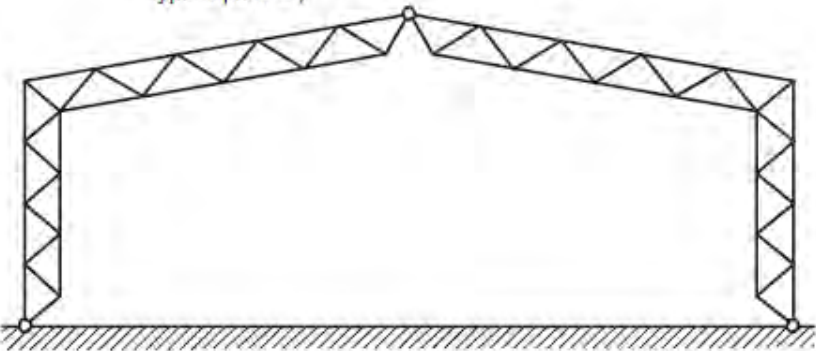

(b) 3 pinned lattice portal (spans up to 80 m)

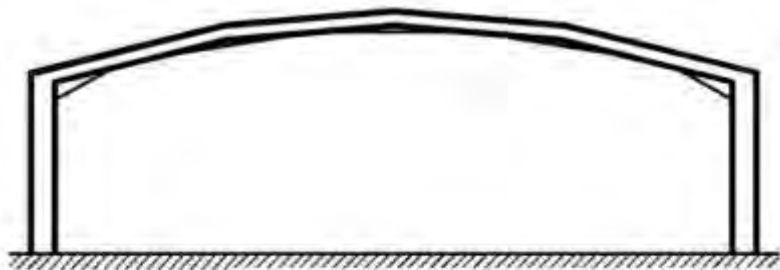

(c) Mansard portal (spans up to 60 m)

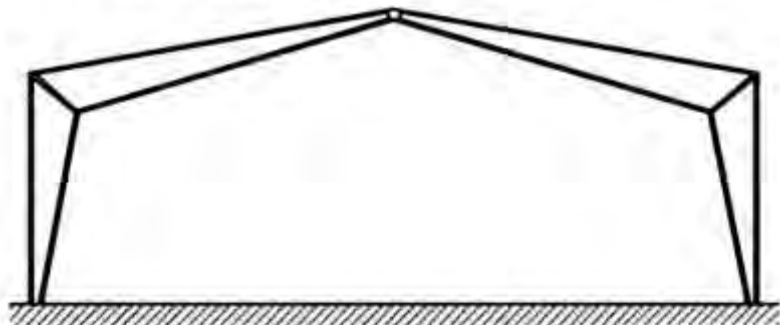

(d) Tapered portal fabricated from plate (spans up to 60 m)

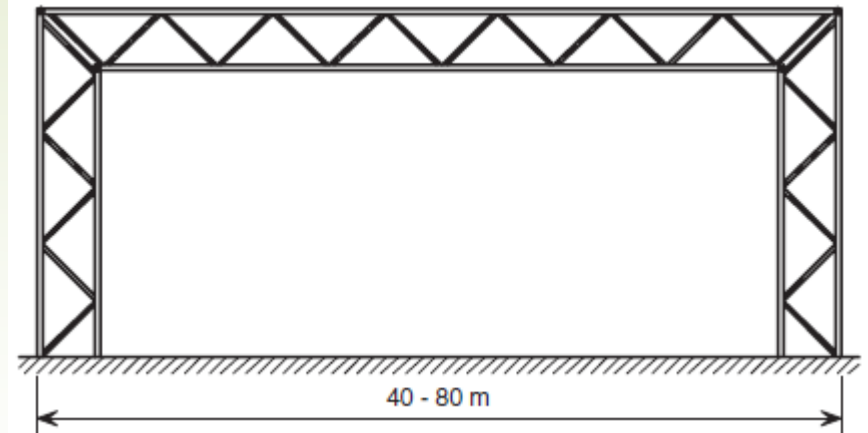

3.9 Articulated lattice portal structure (often using tubular sections)

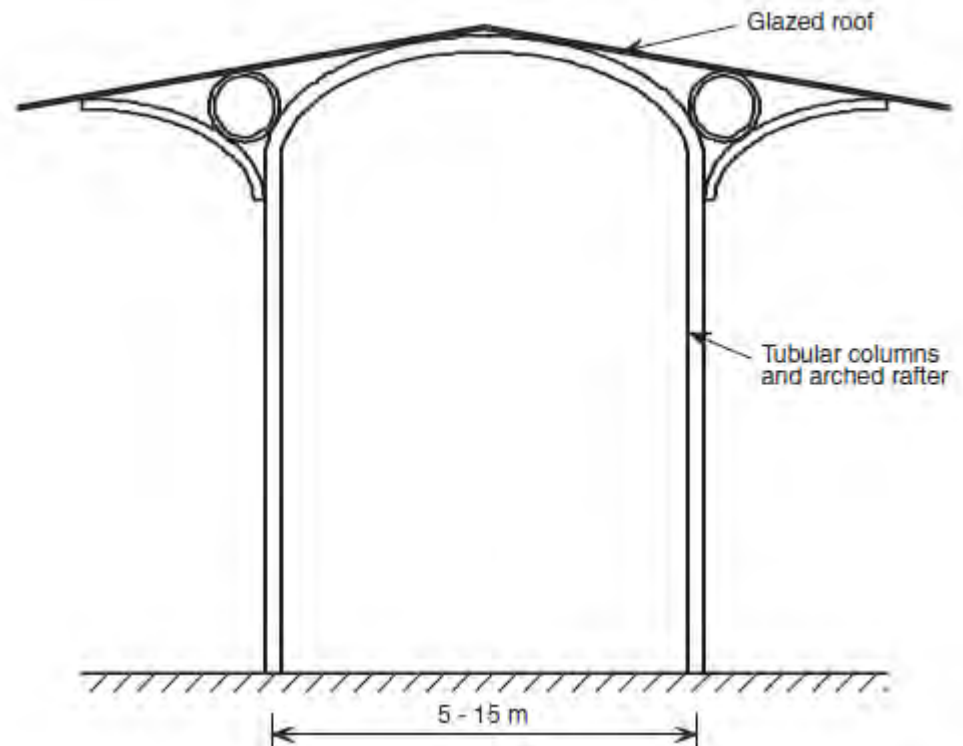

3.10 Arched portal using tubular sections

pre-cast reinforced concrete portal frames

pre-cast concrete purlins fixed across frames to support roof covering and glazing

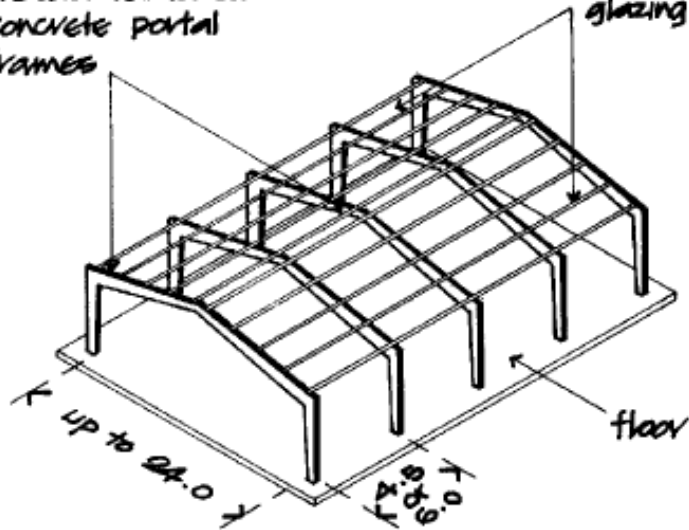

Single bay symmetrical pitch portal frames



circular hollow sections from 21.3 mm to 457 outside diameter

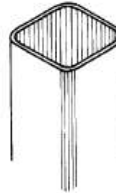

square hollow sections from 20 x 20 to 400 x 400



rectangular hollow sections from 50 x 30 to 450 x 250

Structural hollow sections

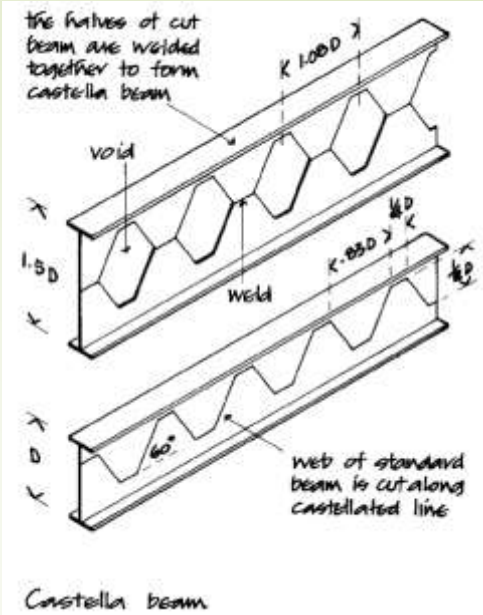

angle section



tee section

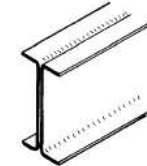

two channels spot welded back to back to form beam section

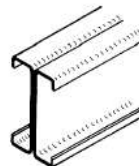

two box channels spot welded back to back to form beam section



channel section



box channel section



two channels welded together to form column section



two box channels welded together to form column section

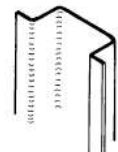

omega (top flut) section



zed section

Cold roll-formed sections welded together to form beam & column sections

Fig. 41

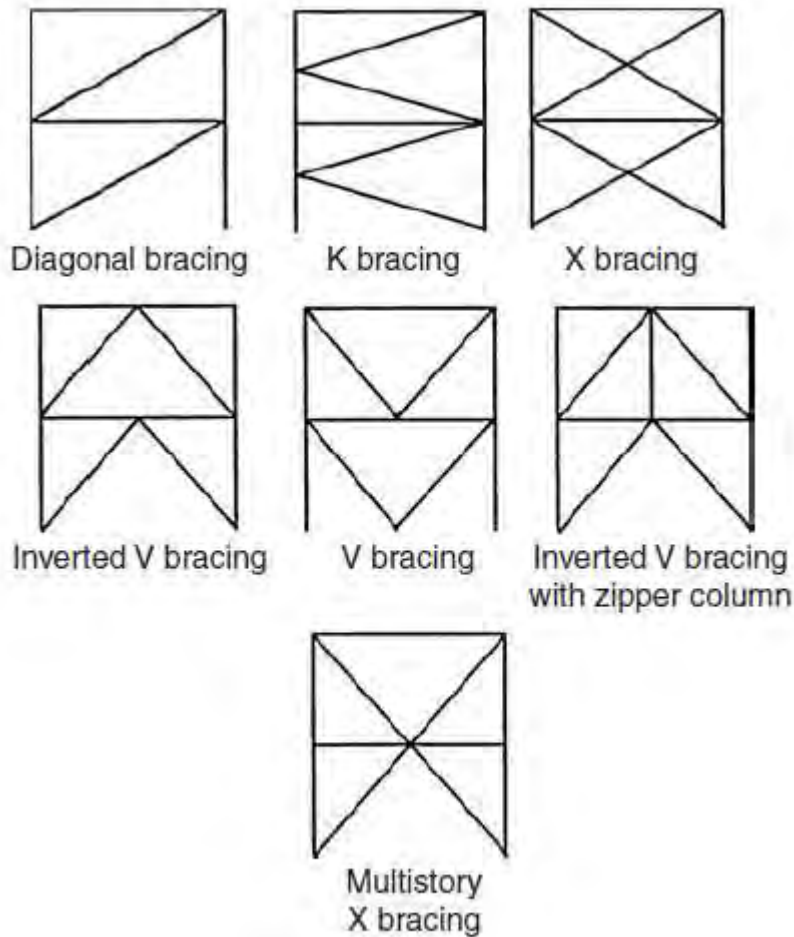
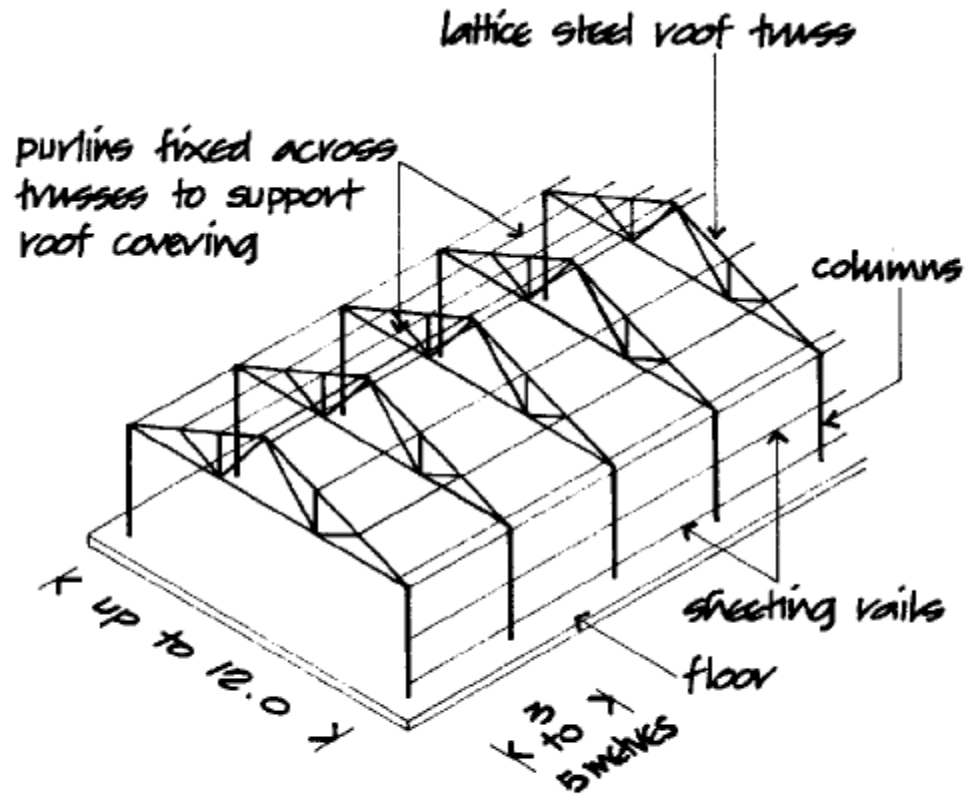
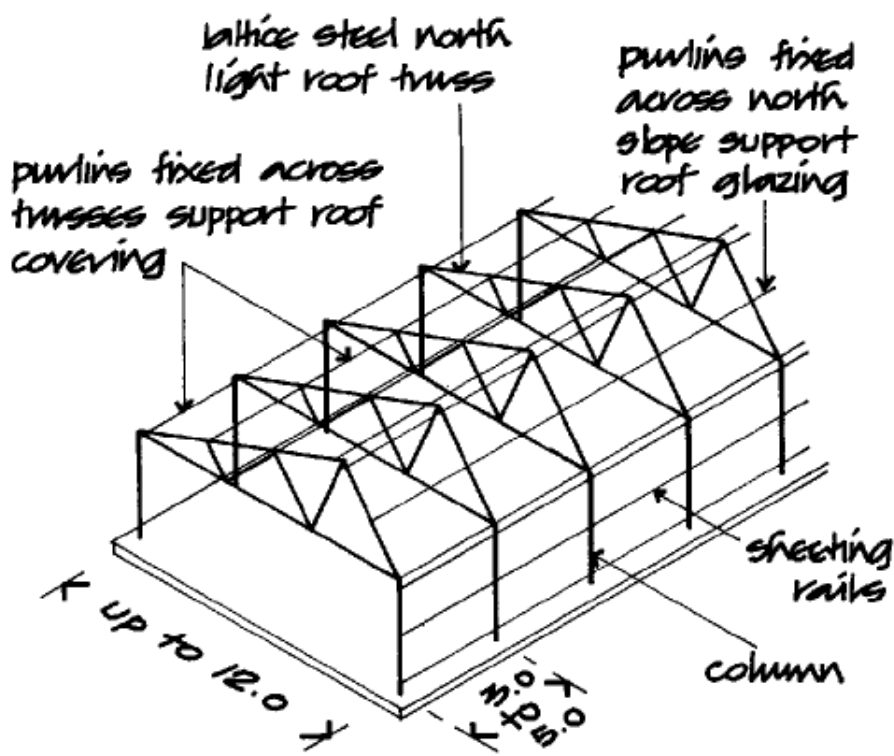

FIGURE 8.6 Typical configurations of concentric braced frames.



Single bay symmetrical pitch lattice steel roof on steel columns



Single bay north light lattice steel roof trusses on steel columns

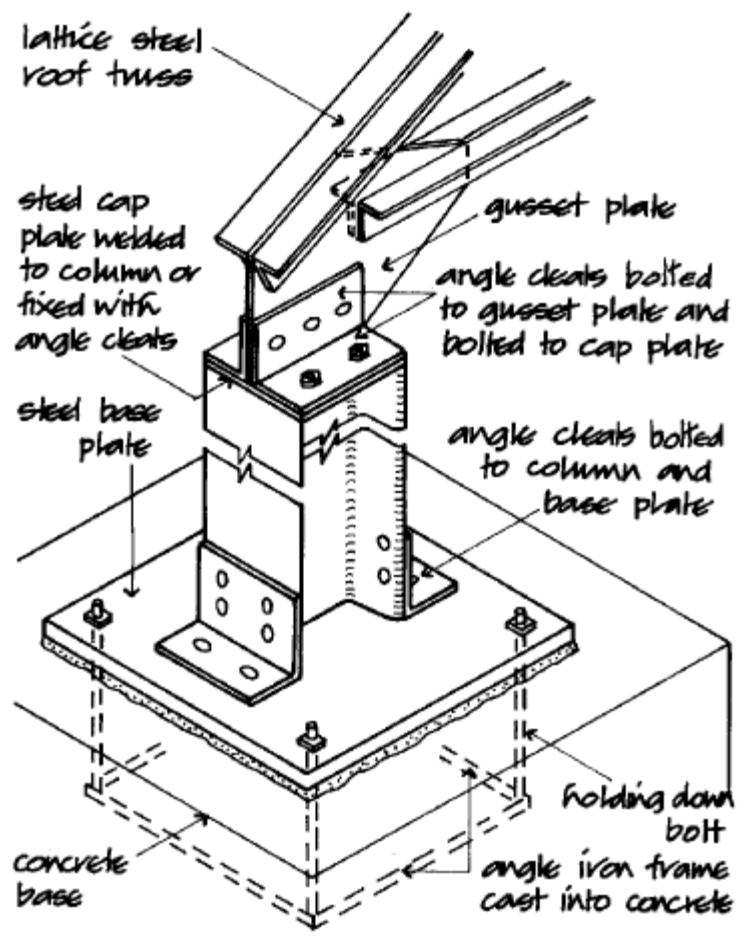

Cap and base of steel column support for lattice steel truss

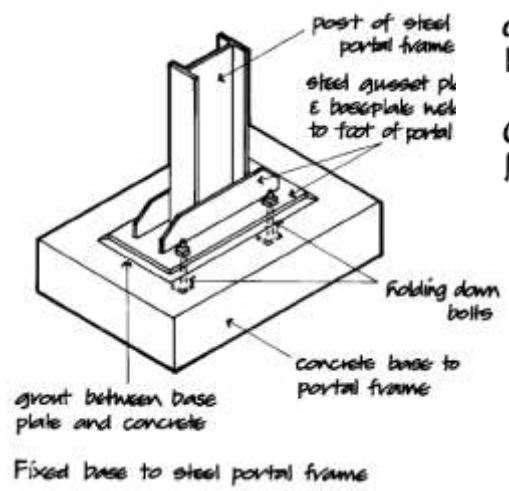

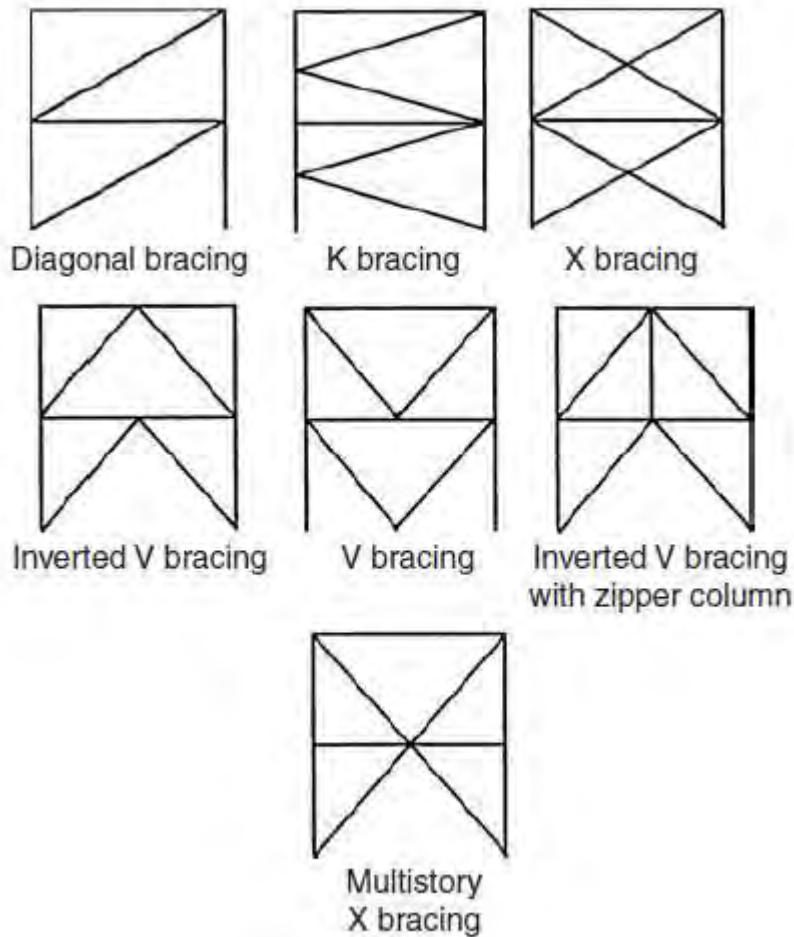
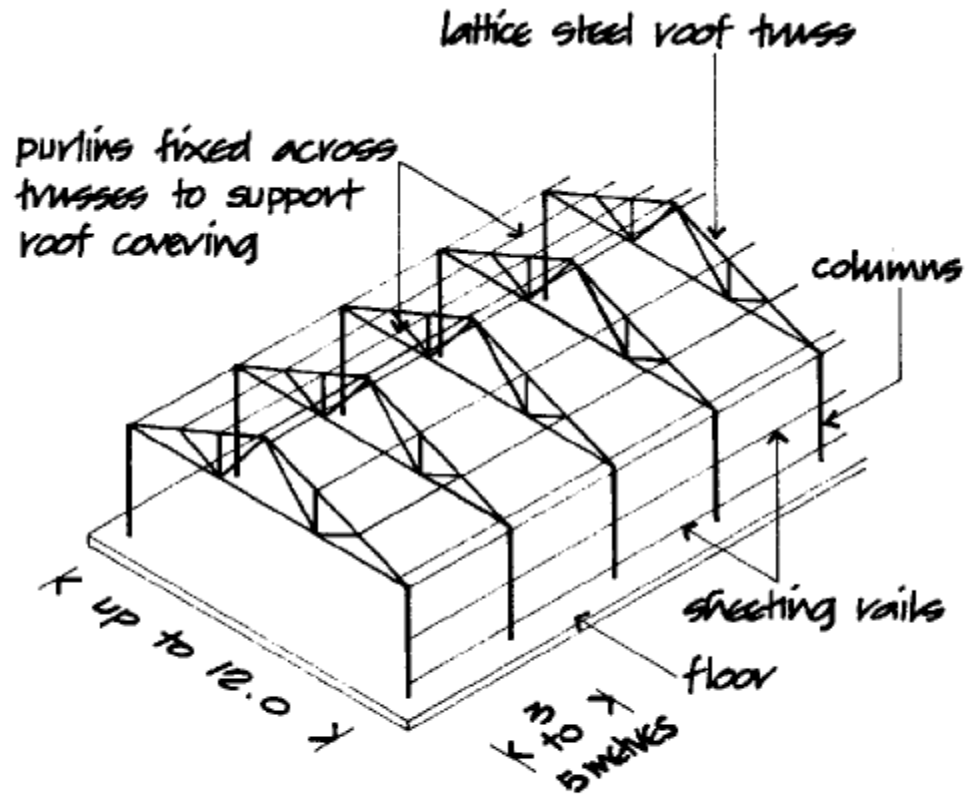
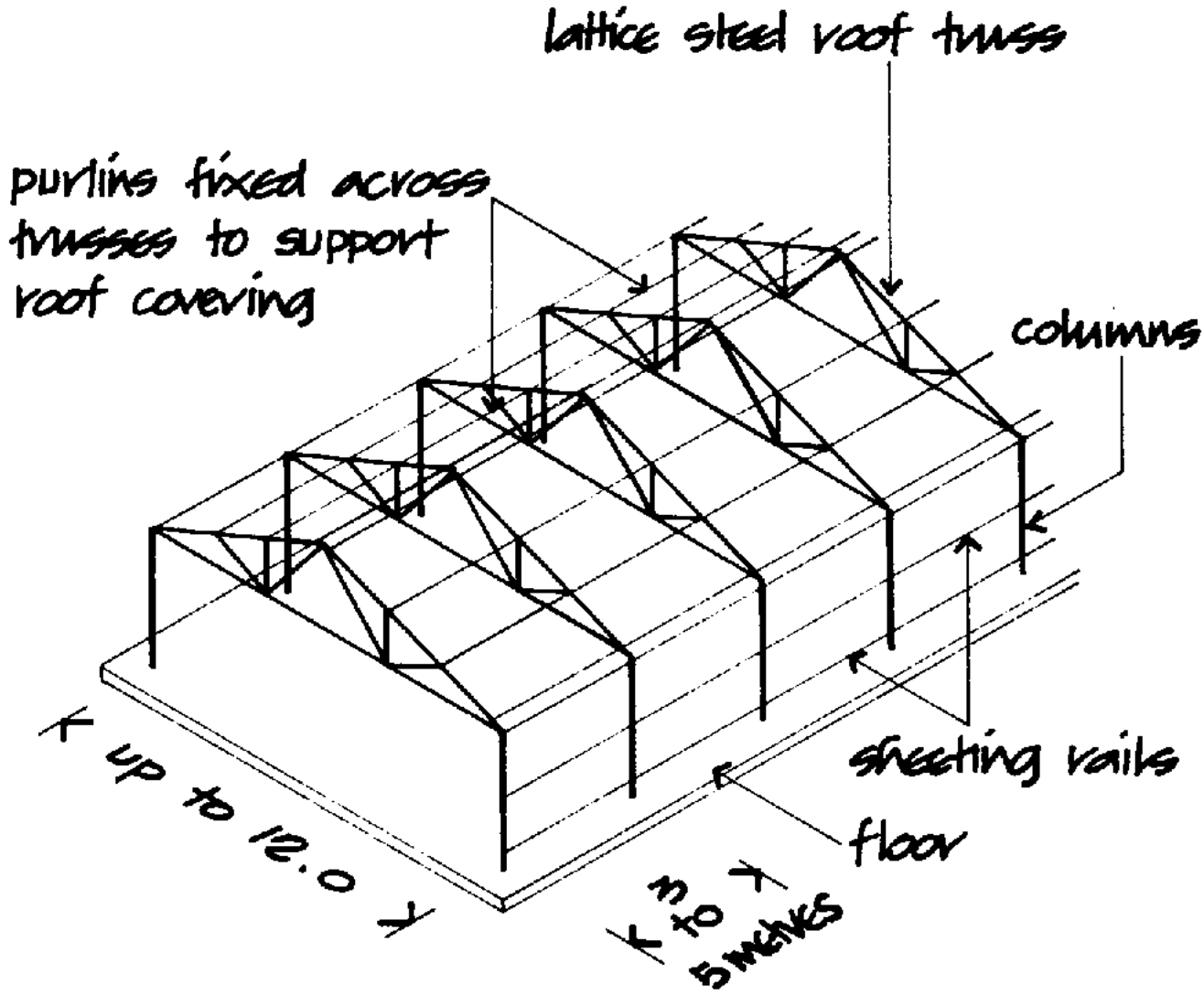

FIGURE 8.6 Typical configurations of concentric braced frames.



Single bay symmetrical pitch lattice steel roof on steel columns



Single bay symmetrical pitch lattice steel roof on steel columns

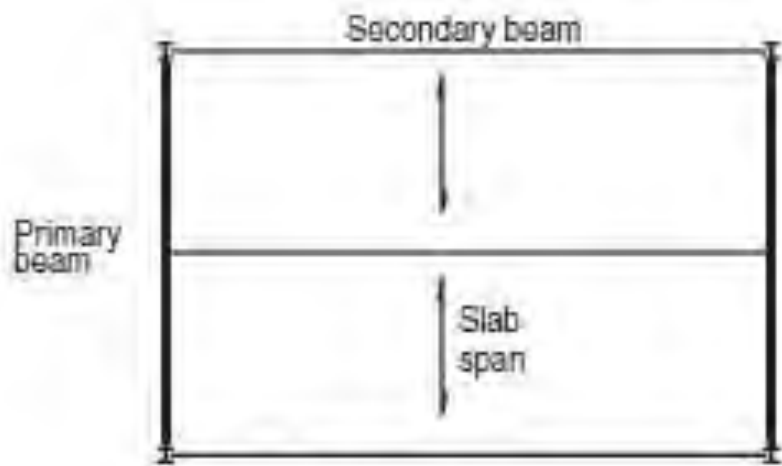

(a) Typical floor layout where beams are of equal depth
(Note: orientation of columns means secondary beams are of equal length)

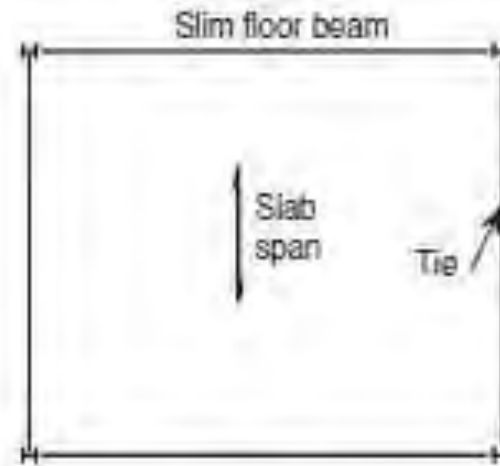

(b) Typical floor layout using slim floor beams
(Note: ties embedded in slab)

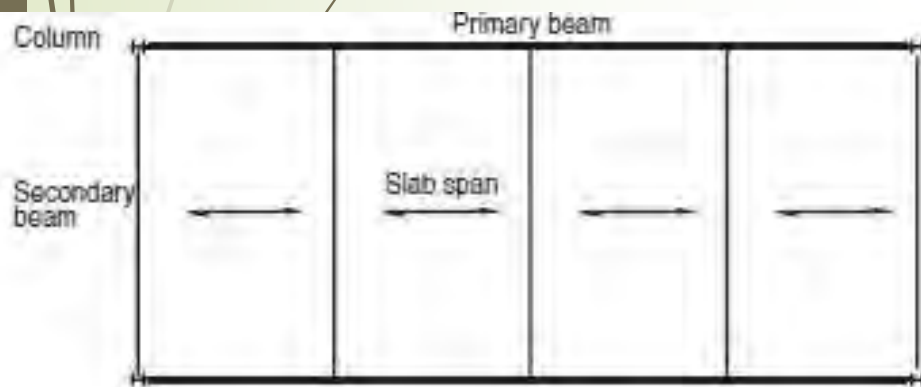

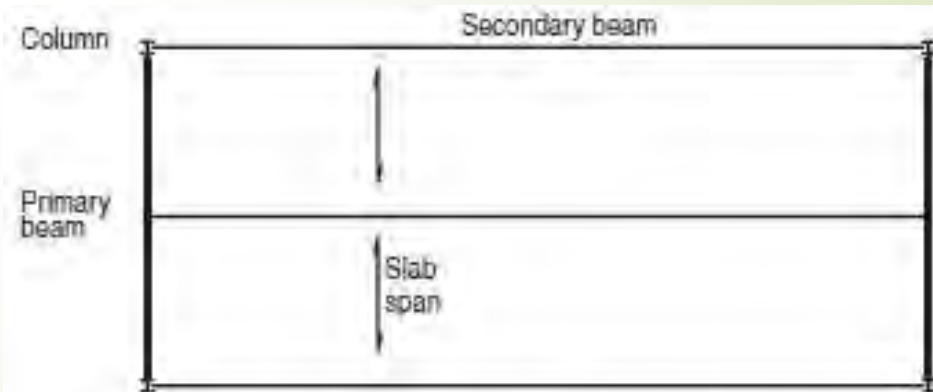

(c) Long-span floor beams (scheme 1 - heavily loaded primary beams)
(Note: framing into major axis of column)

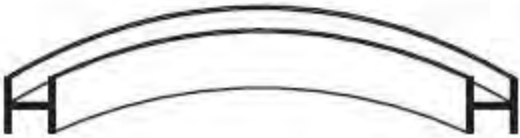

(d) Long-span floor beams (scheme 2 - short-span primary beams)

Table 4.2 Minimum bending radii for common steel sections

	Section	Typical radius
	Joists and Universal Beams (<i>x-x</i> axis)	
	610 × 305 × 238 kg/m UB	40.0 m
	533 × 210 × 122 kg/m UB	30.0 m
	406 × 178 × 74 kg/m UB	15.0 m
	254 × 203 × 82 kg/m RSJ	3.5 m
	203 × 152 × 52 kg/m RSJ	2.2 m
	152 × 127 × 37 kg/m RSJ	1.6 m
	Universal Columns (<i>x-x</i> axis)	
	152 × 152 × 37 kg/m	2.0 m
	203 × 203 × 86 kg/m	3.0 m
	254 × 254 × 167 kg/m	4.0 m
	305 × 305 × 283 kg/m	5.0 m
All sections up to 356 × 406 UC		
	Channels (<i>x-x</i> axis)	
	127 × 64 × 14 kg/m	2.0 m
	203 × 89 × 29 kg/m	3.0 m
	254 × 89 × 35 kg/m	5.0 m
	305 × 102 × 46 kg/m	7.0 m
All sections up to 432 × 102 × 65 kg/m		
	Joists, beams and columns (<i>y-y</i> axis)	
	127 × 76 × 16 kg/m	0.8 m
	230 × 133 × 30 kg/m	1.5 m
	457 × 191 × 98 kg/m	2.5 m
	610 × 229 × 140 kg/m	3.0 m
All sections up to 1016 × 455 × 488 kg/m		



Castellated and cellular beams (x-x axis)

305 × 133 × 30 kg/m	4.0 m
458 × 165 × 54 kg/m	8.0 m
609 × 178 × 74 kg/m	12.0 m
800 × 210 × 122 kg/m	16.0 m
915 × 305 × 238 kg/m	20.0 m

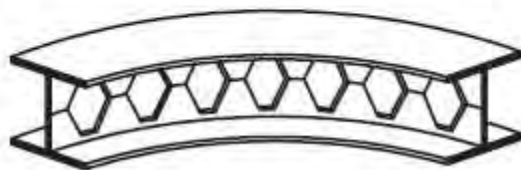

Castellated and cellular beams (y-y axis)

305 × 133 × 30 kg/m	2.0 m
458 × 165 × 54 kg/m	3.0 m
609 × 178 × 74 kg/m	4.0 m
800 × 210 × 122 kg/m	6.0 m
915 × 305 × 238 kg/m	8.0 m

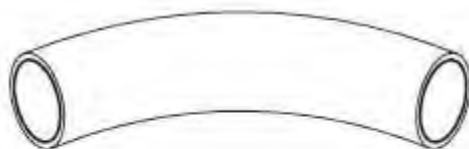

Circular Hollow Sections

60.3 × 5 mm	0.4 m
114.3 × 6.3 mm	0.7 m
168.3 × 10 mm	0.9 m
219.1 × 12.5 mm	1.1 m
Most sizes up to 610 mm o/d × 35 mm	

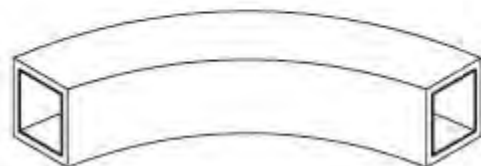

Square and Rectangular Hollow Sections

50 × 50 × 5 mm	0.6 m
100 × 100 × 6.3 mm	1.1 m
150 × 150 × 10 mm	1.4 m
200 × 200 × 12.5 mm	2.0 m
All sizes up to 400 × 400 × 16 SHS and 500 × 300 × 20 RHS	



For free spans up to 25 m, hot-rolled sections are preferred



For longer spans trussed beams are a popular alternative



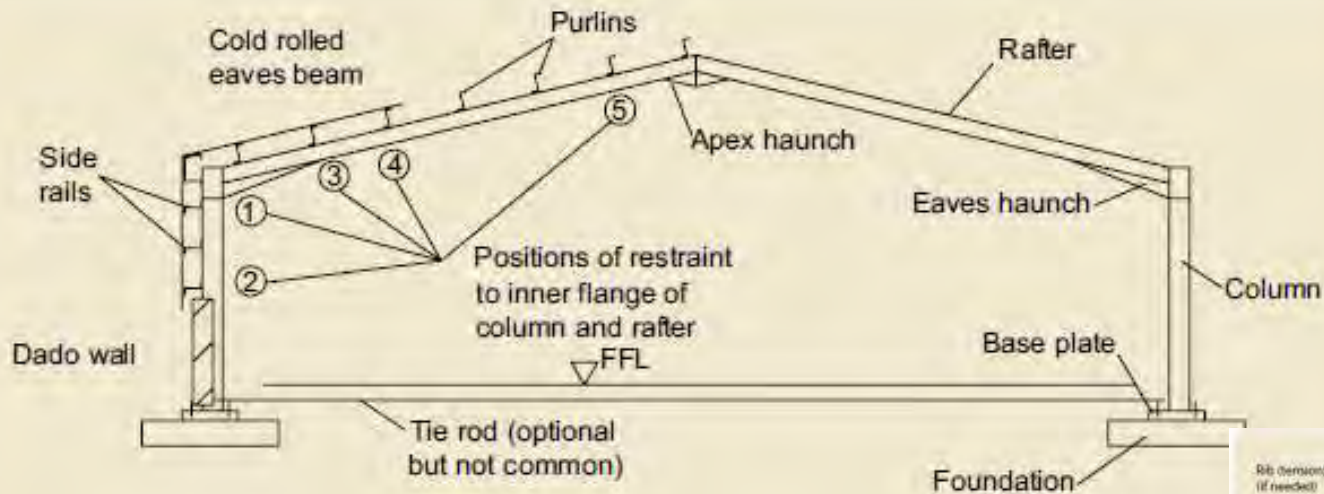

(a) Cross-section showing the portal frame and its restraints

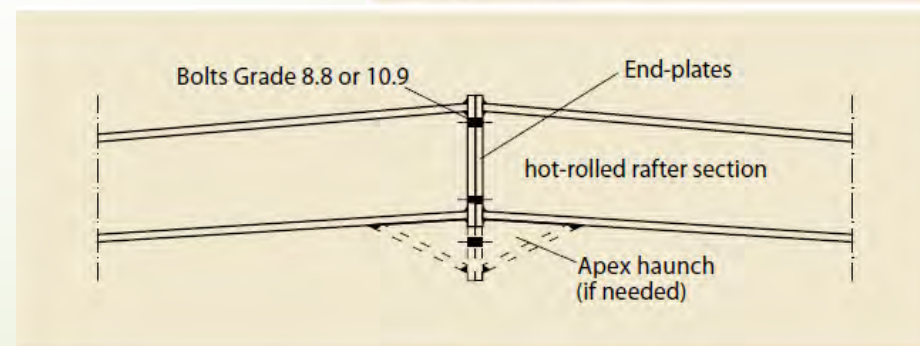
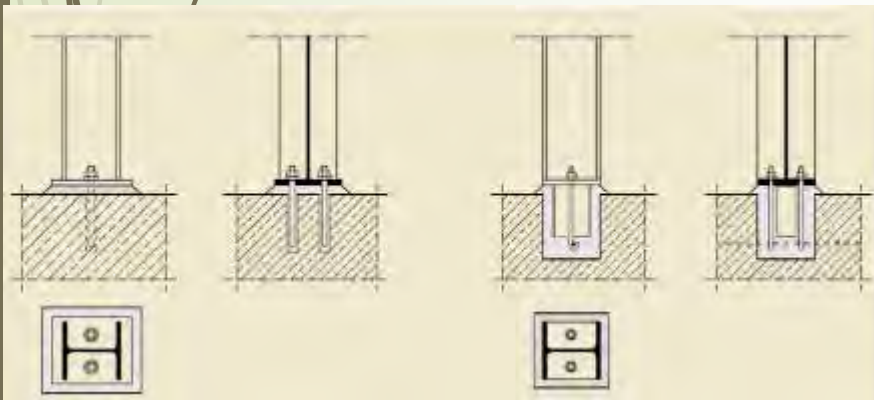
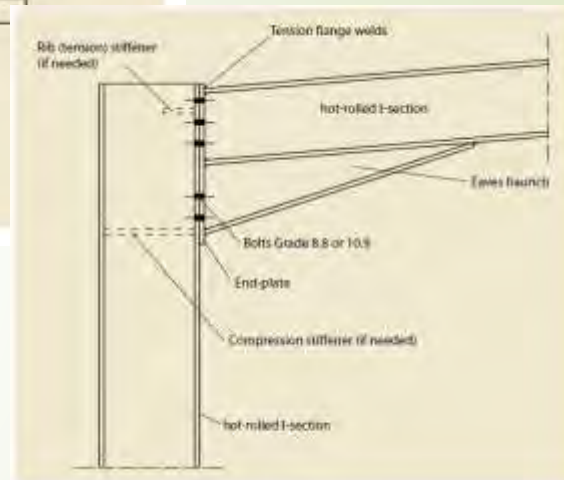

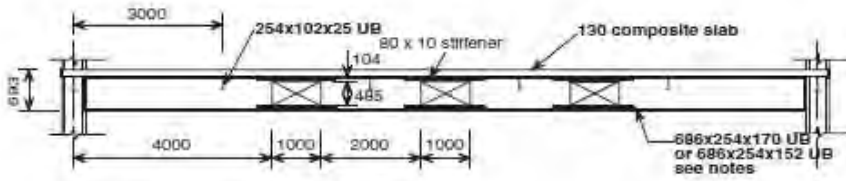

Notes: 485 deep openings : 686x254x170 UB
450 deep openings : 686x254x152 UB

(a) Beam with rectangular web openings

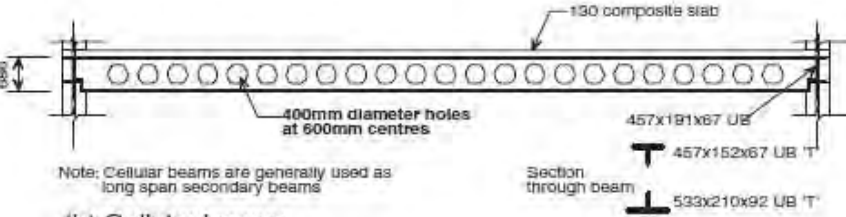

Note: Cellular beams are generally used as long span secondary beams

(b) Cellular beams

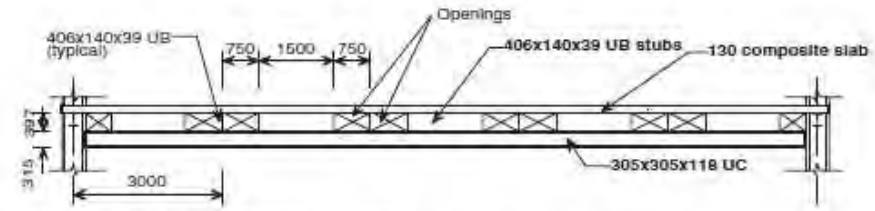

Note: Requires propping during construction

Note (to all figures): Shear connectors not shown

(c) Stub girder

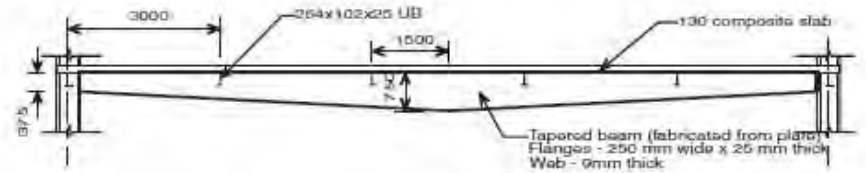

(d) Tapered beam

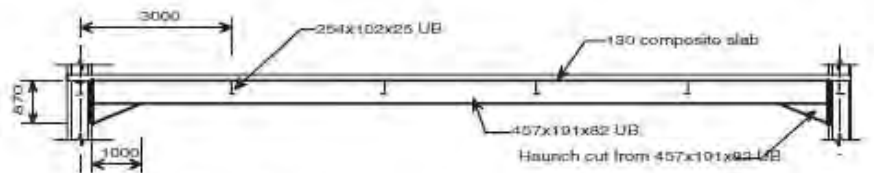

Note: Requires heavier columns

(e) Haunched beam

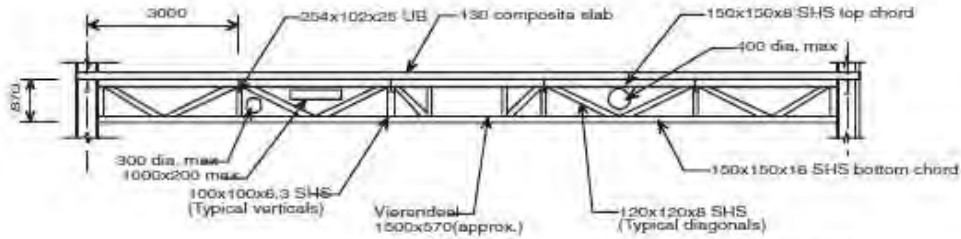

Alternative T and Angle sections:
Top chord = 305x152x49 kg/m T
Bottom Chord = 305x152x80 kg/m T
Diagonals = 2 No 120x120x12kg/m Angle

Note (to all figures): Shear connectors not shown

(f) Composite truss

4.10 Long-span composite beams offering the facility for service integration (designed for 15 m x 6 m floor grid)

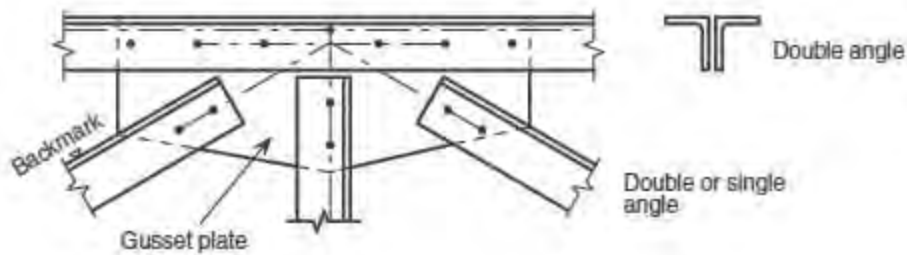

(a) Typical bracing-chord bolted connection using angle chords

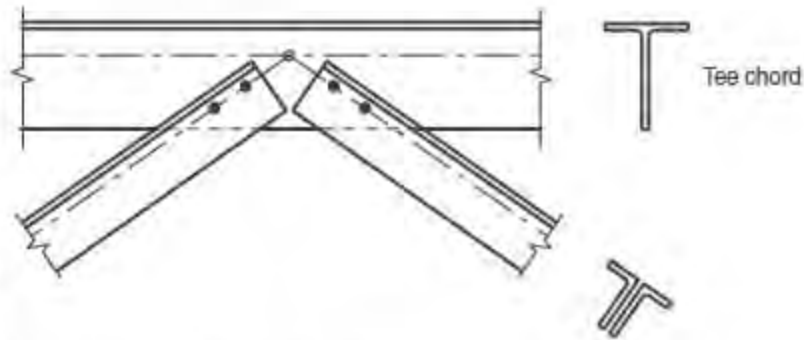
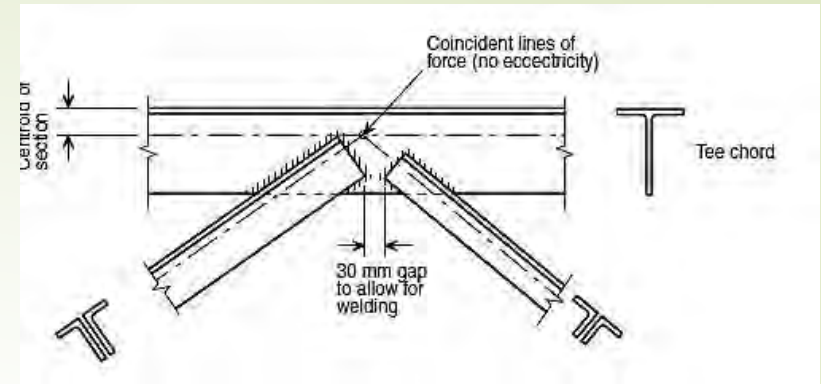

(b) Typical bracing - chord connection using T section chord

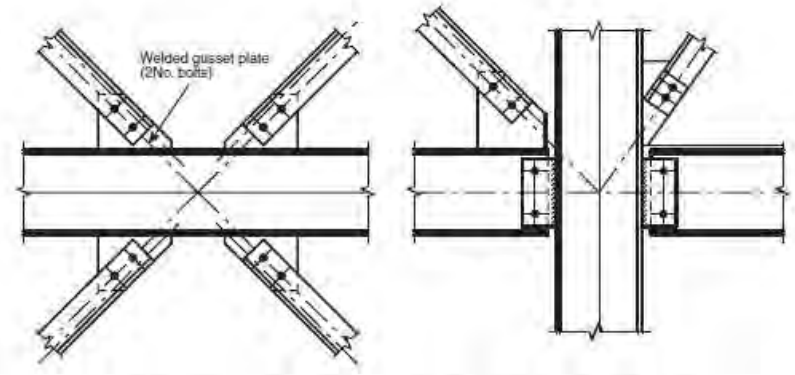

(a) Bracing connection to beam

(b) Bracing connection to either beam or column

5.12 Traditional bolted connections in trusses

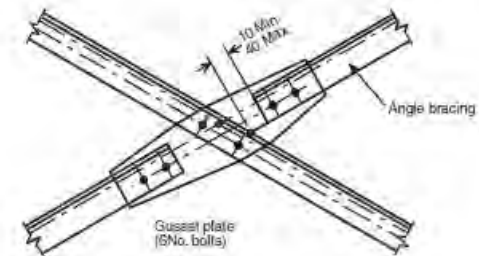

(c) X-Bracing (back to back or single angle)

5.15 Examples of bracing connections in frames using angle sections

Different Types of Steel Section used in Trusses

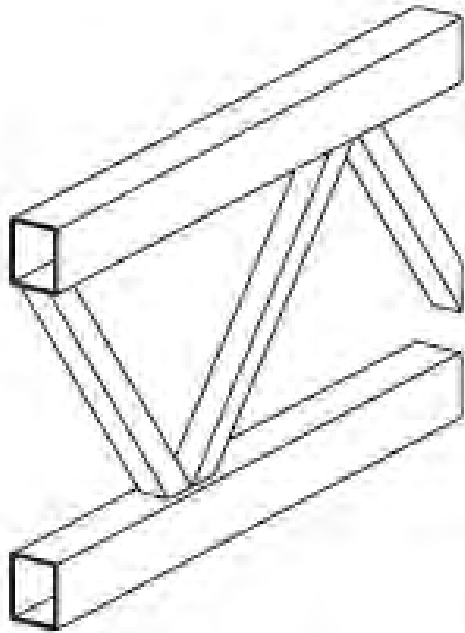

(a) RHS or SHS

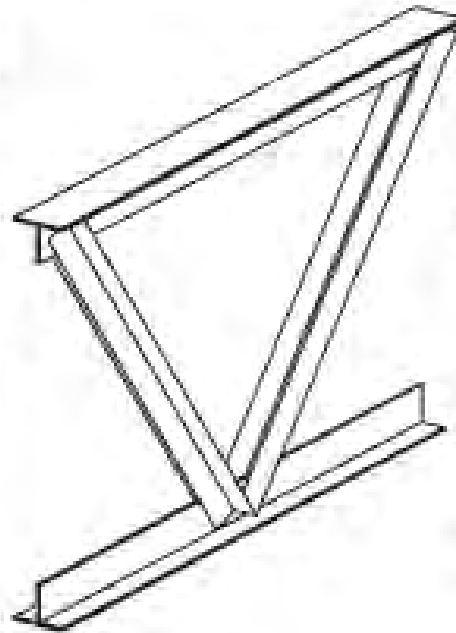

(b) T' Section

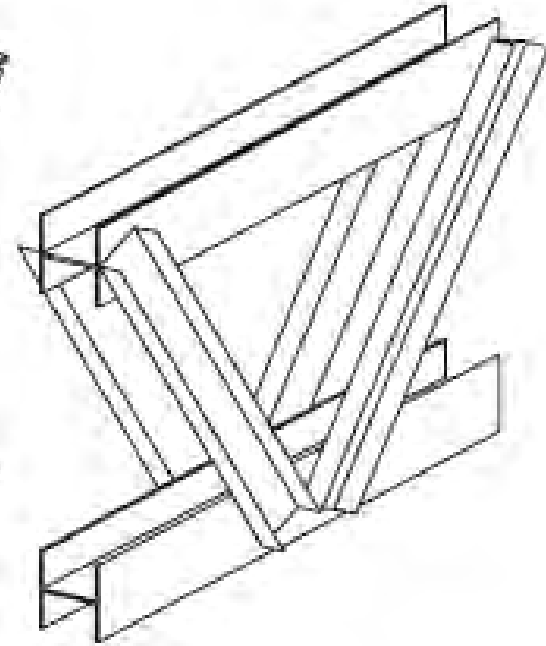

(c) UG Chord

Traditional bolted connections in Trusses

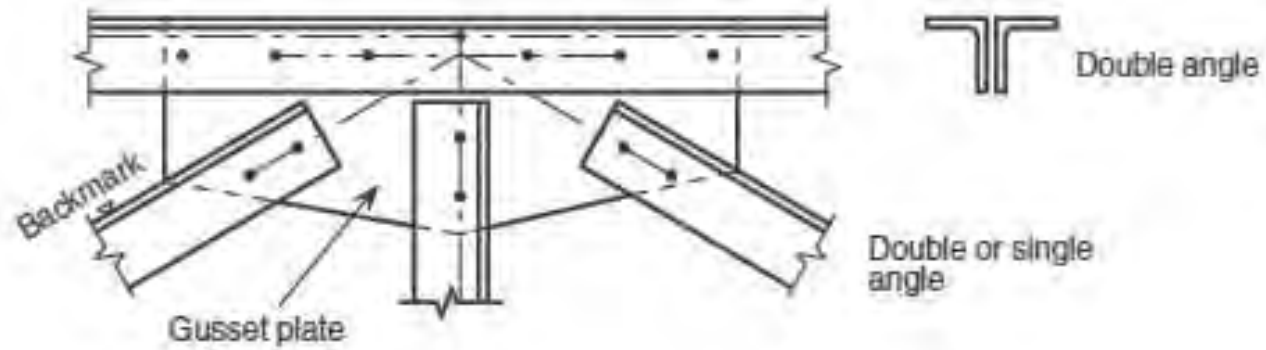

(a) Typical bracing-chord bolted connection using angle chords

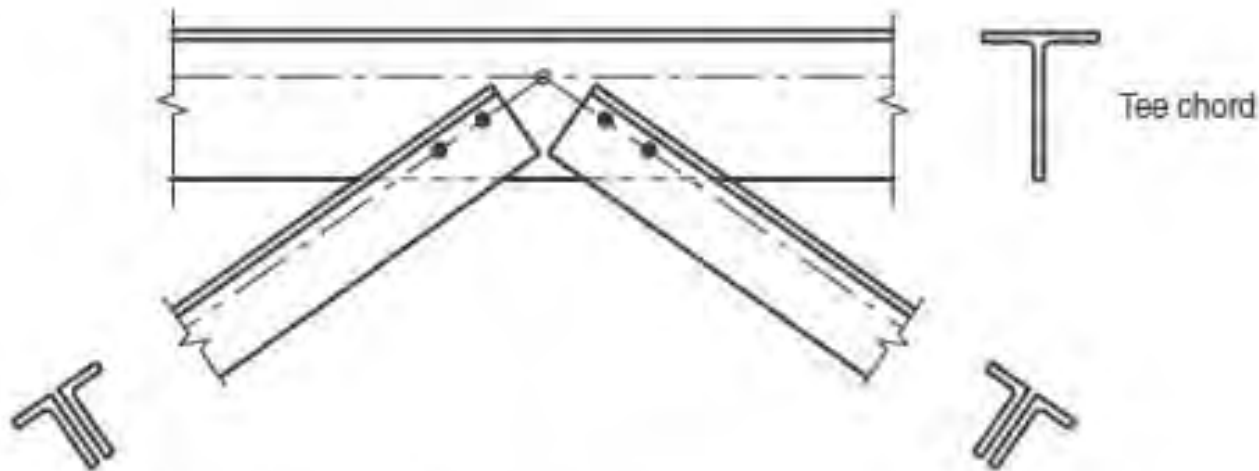

(b) Typical bracing - chord connection using T section chord

Examples of bracing connections in frames using angle sections

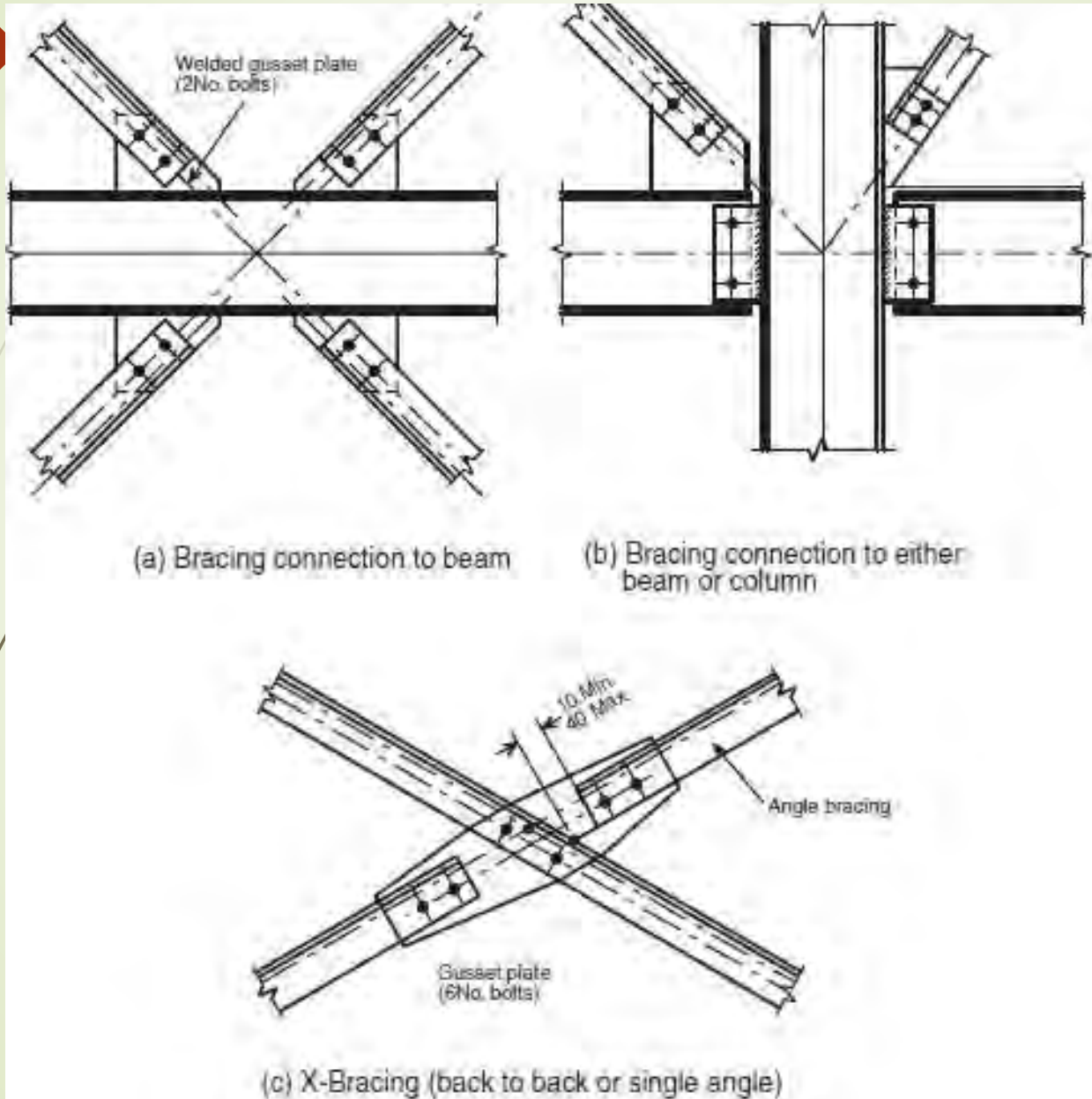

Types of Columns

- H beam, Steel Column
- **Lattice Column**
- Round Column
- Box Column
- Cross-shaped Column

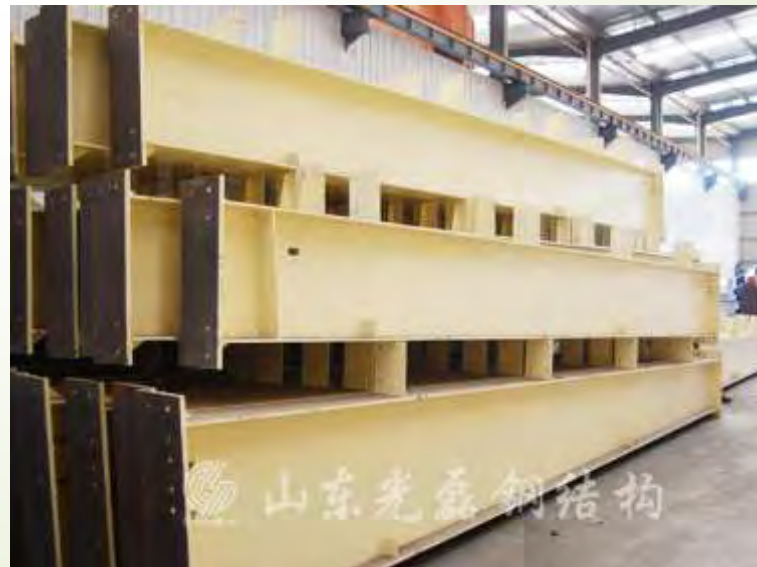

Lattice column



Circular Column

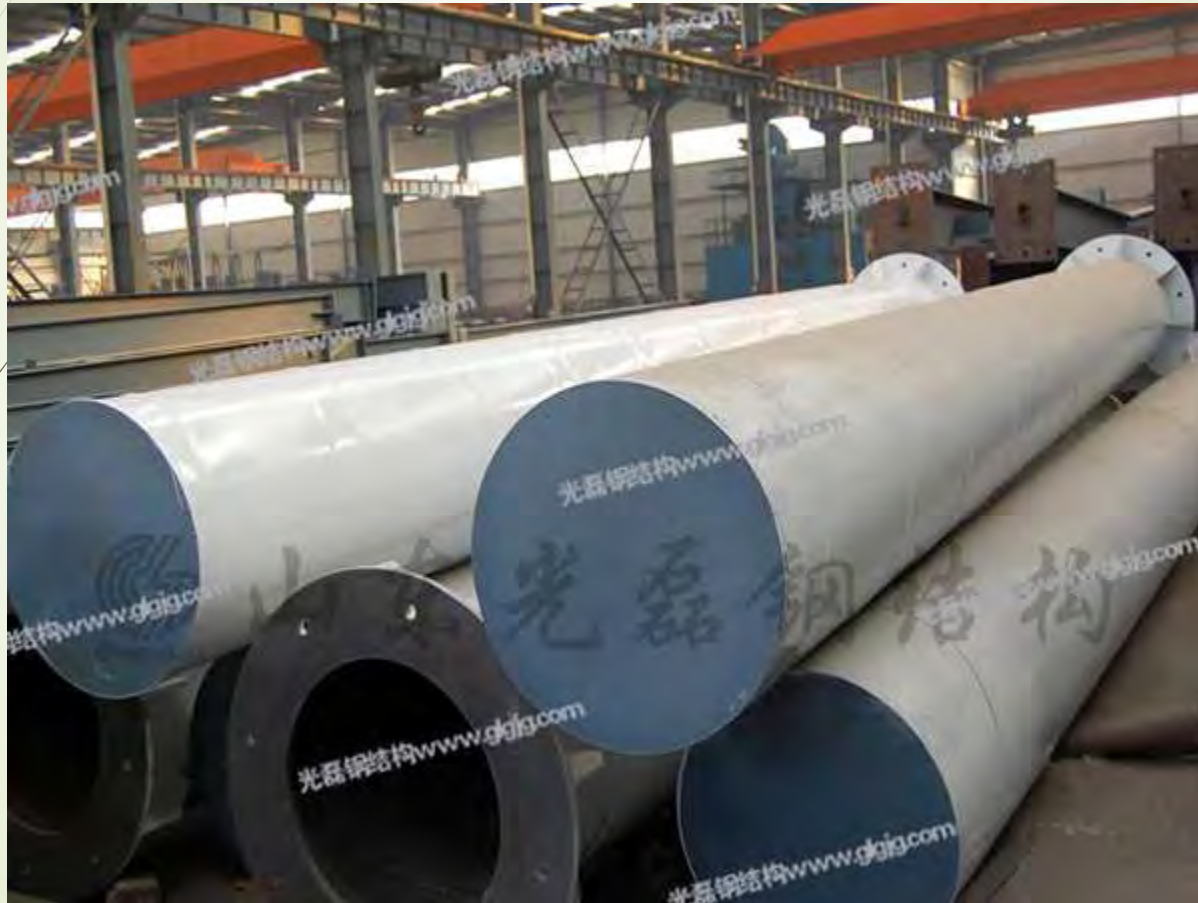

Box column

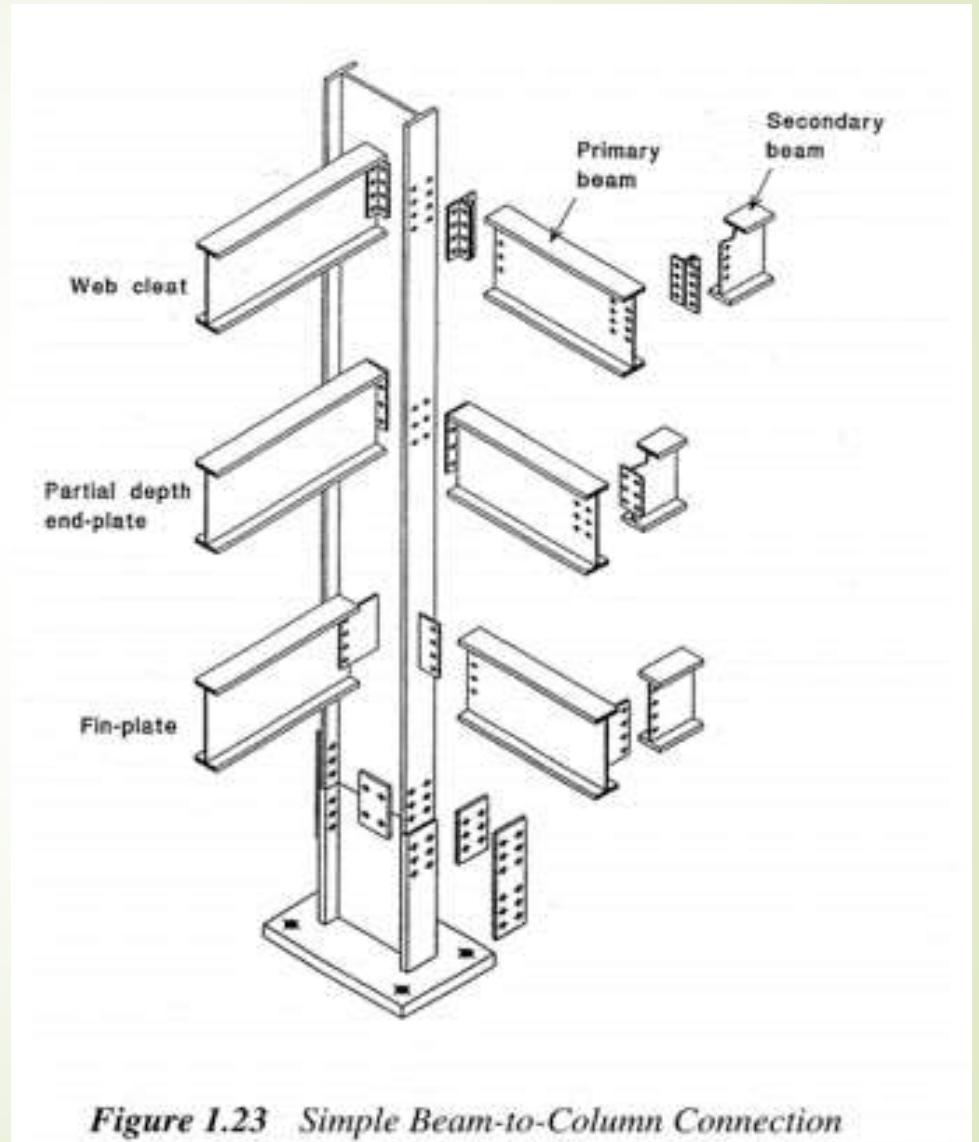

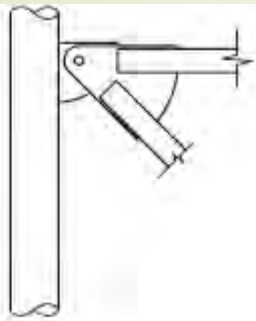
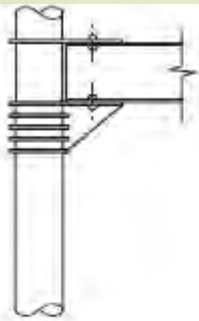



Photo courtesy: Thinkstock

The connection between beams and column





Pinned connections

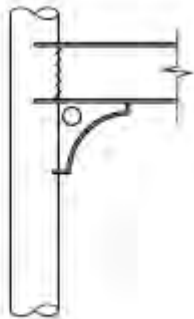
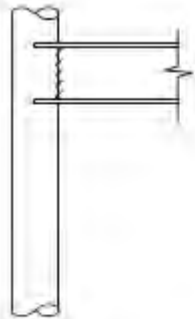

Rigid connections

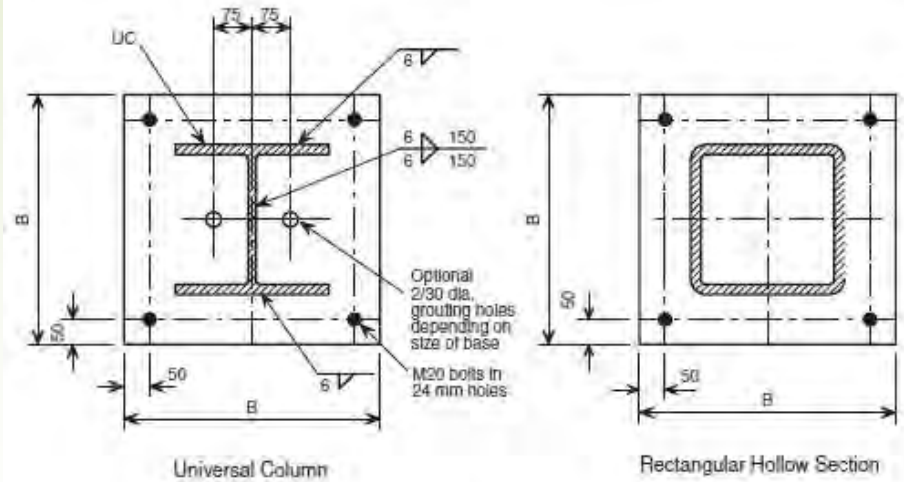

Universal Column

Rectangular Hollow Section

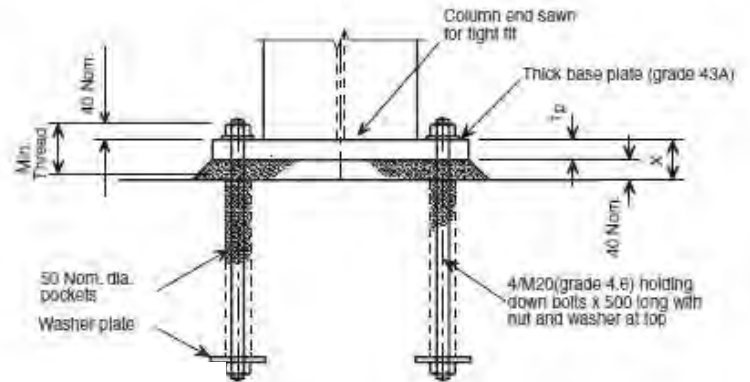

4.24 Tubular columns with pinned or rigid connections

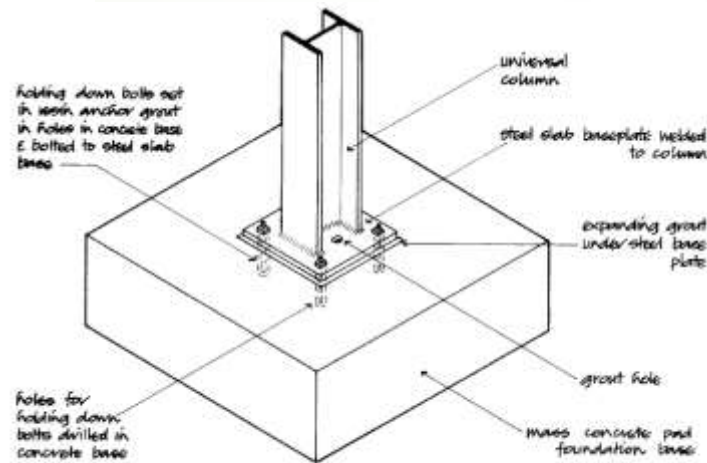

Steel slab base on concrete pad foundation

Fire Protection of Structural Steelwork using Metal lath and plaster casing

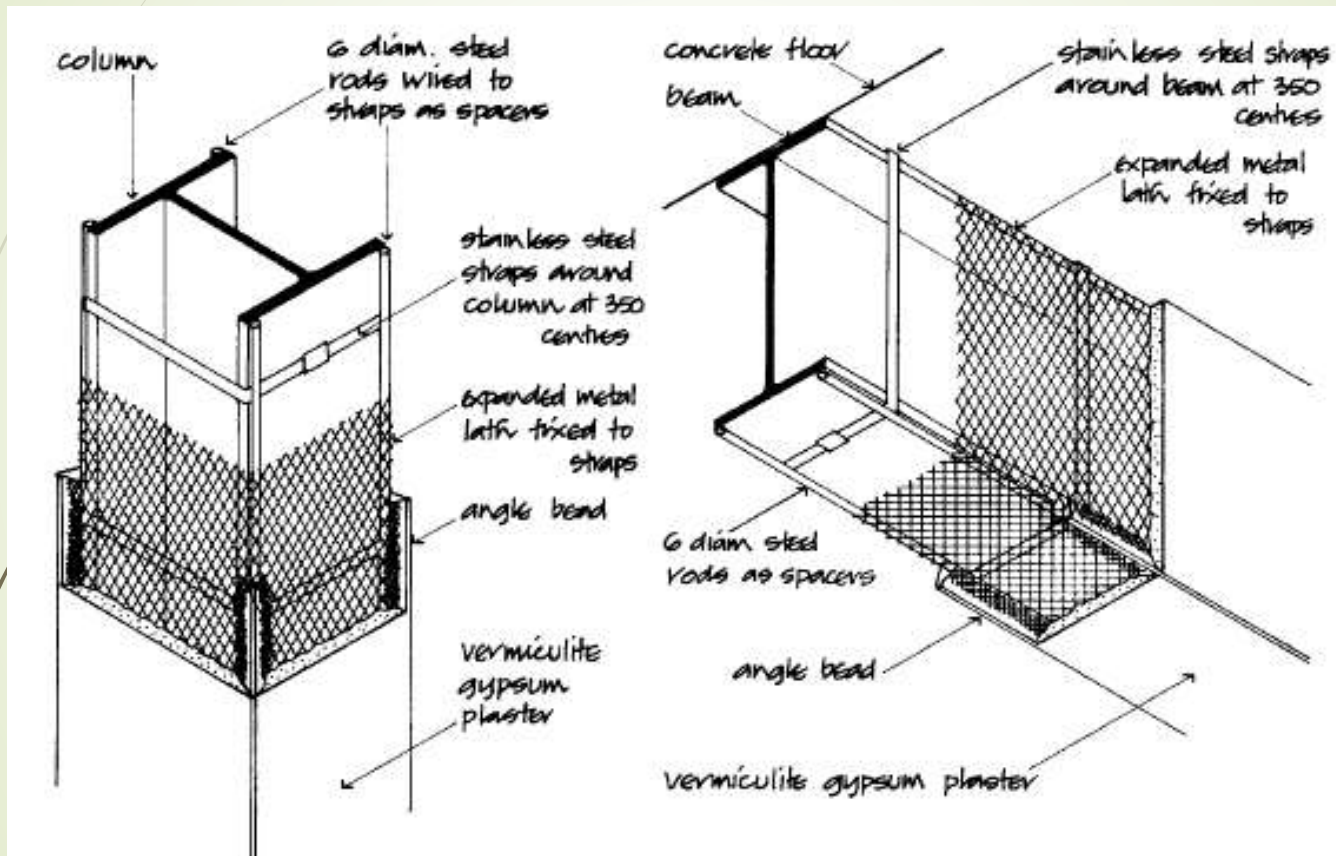

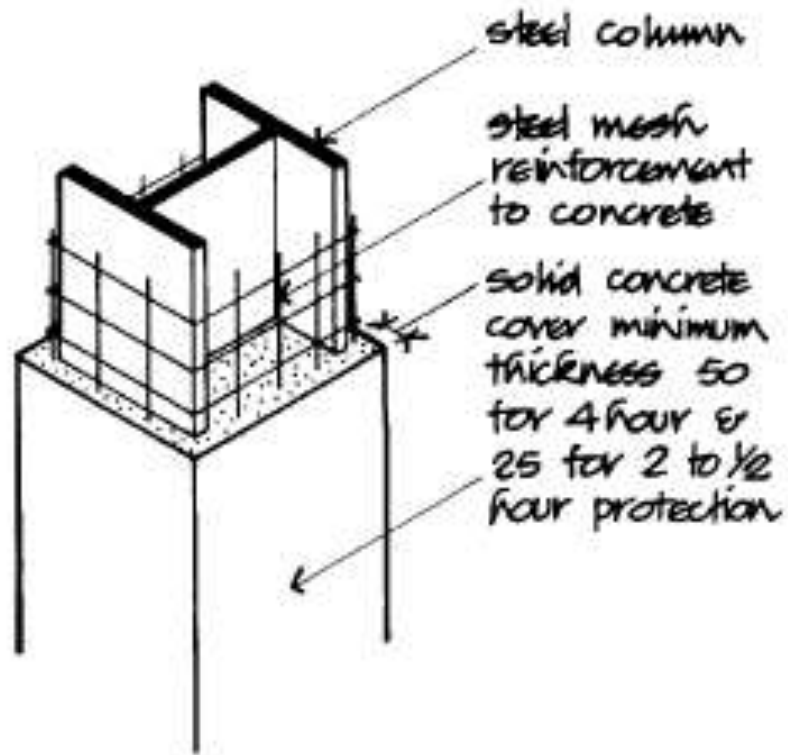

Non structural solid concrete fire protection to steel column

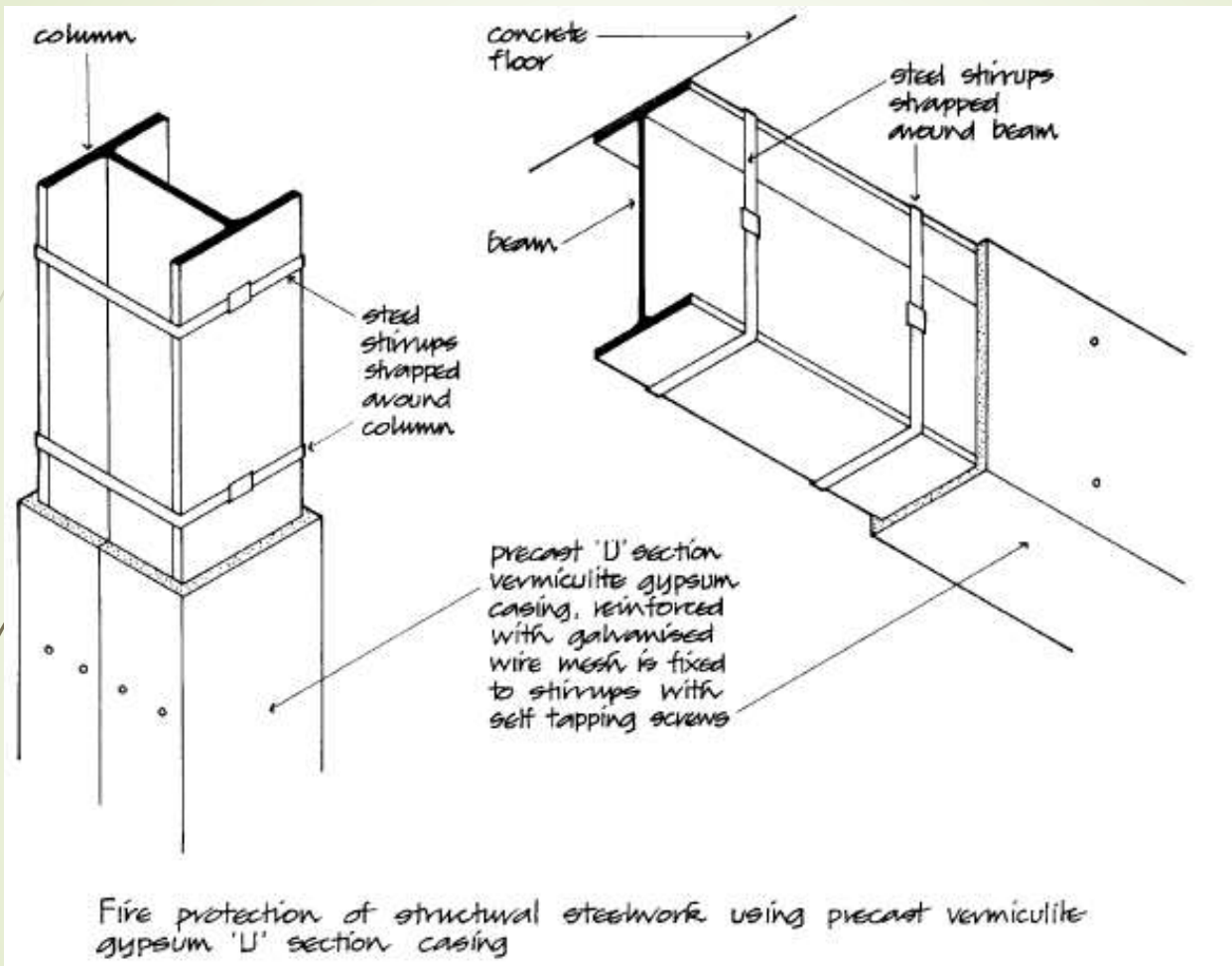

Structural Steelwork Connections

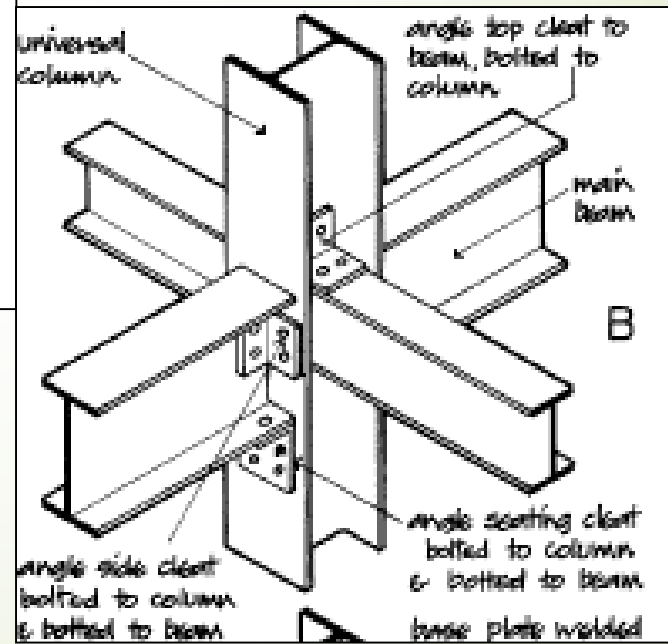
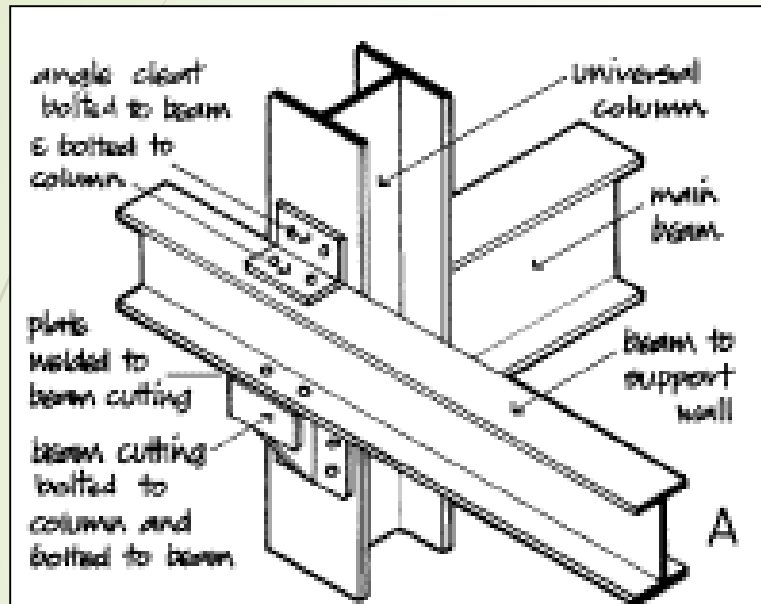

end of beam
notched to fit
inside top flange
of main beam

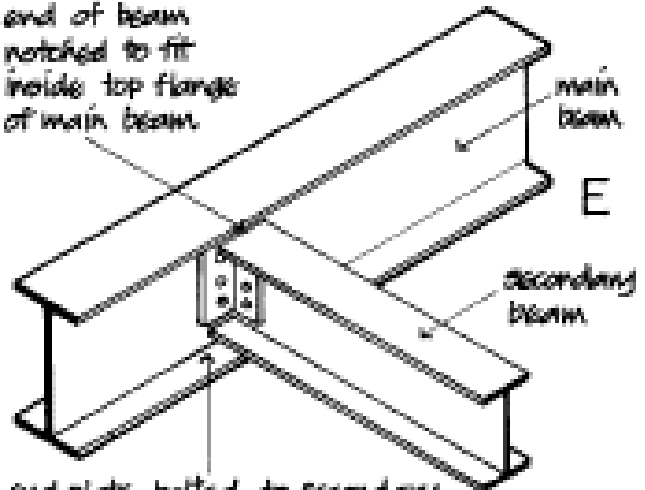

main
beam

E

secondary
beam

end plate bolted to secondary
beam and bolted to main beam

packing
plate

splice plate
bolted to top
column and
welded to
lower column

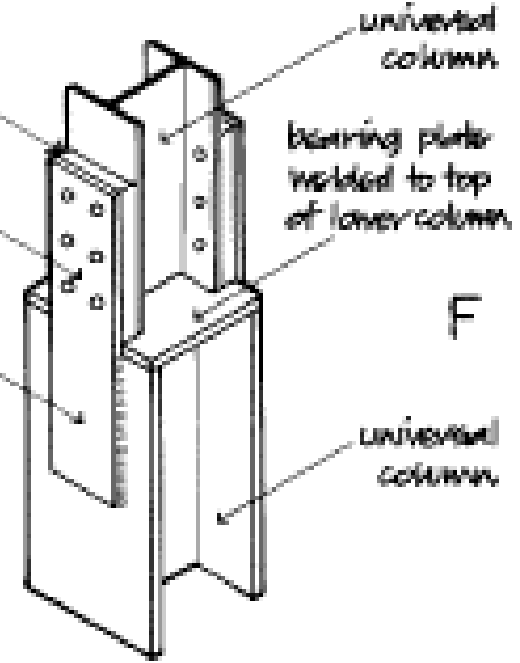

universal
column

bearing plate
welded to top
of lower column

F

universal
column

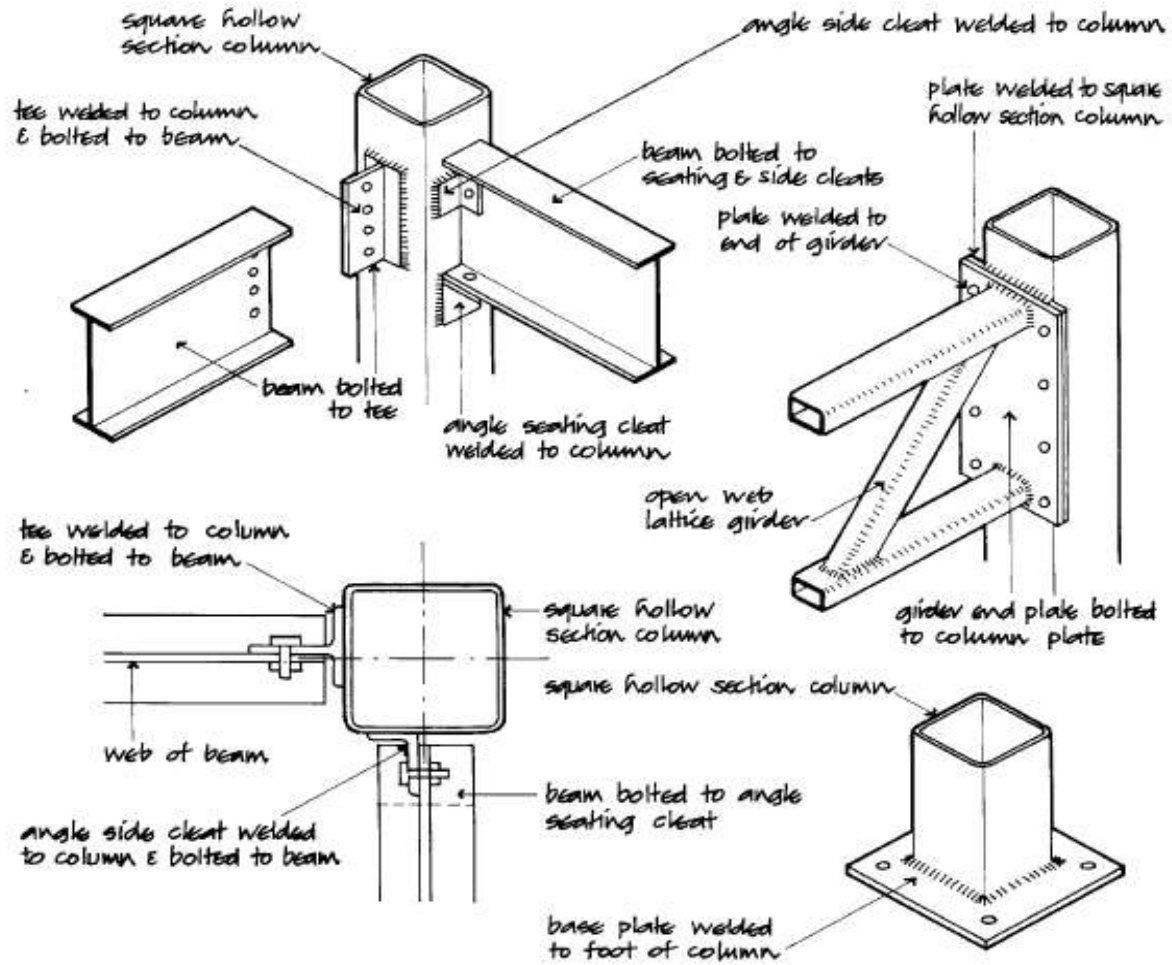

Connections to hollow section columns

Secondary membranes

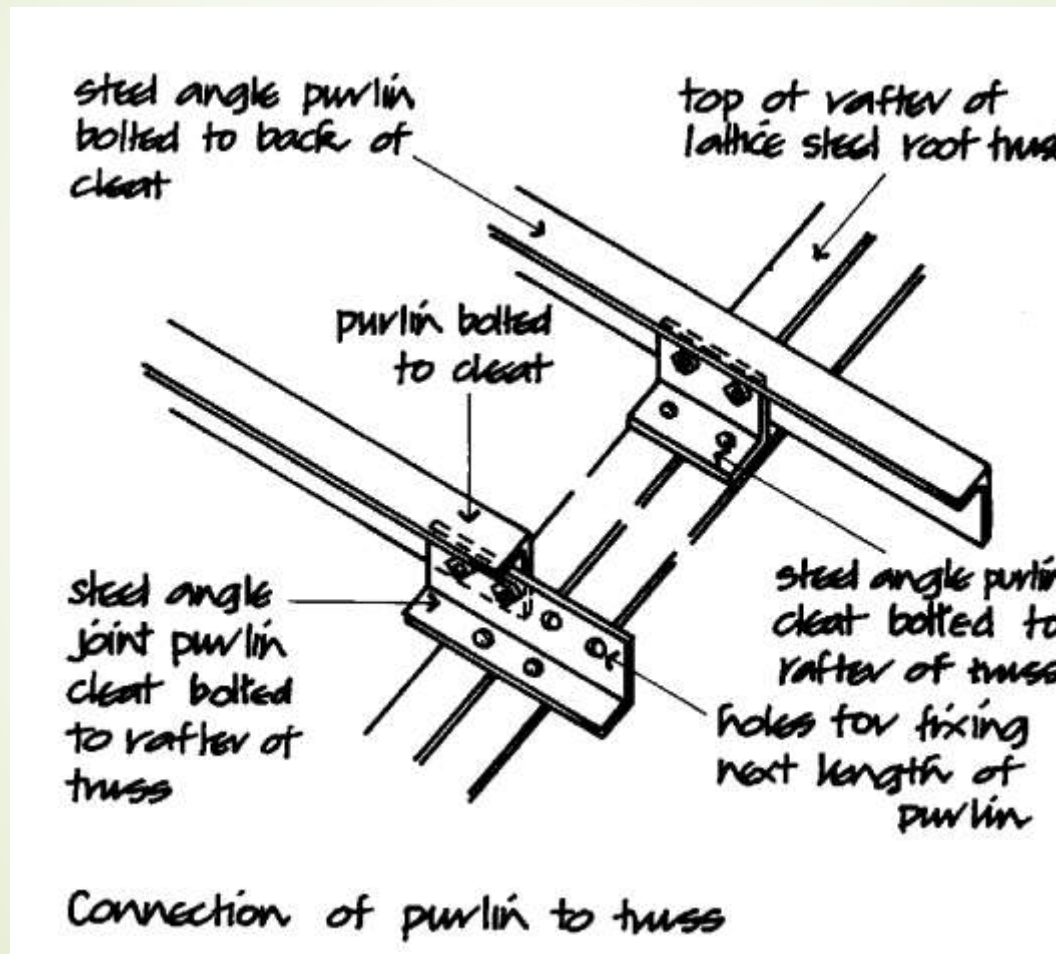

Secondary membranes

mild steel
angle purlin
or rail

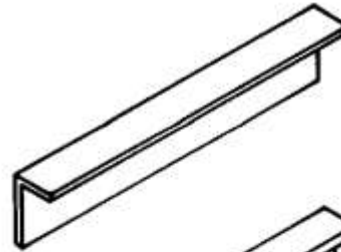

galvanised
steel sigma
Multibeam
purlin or rail

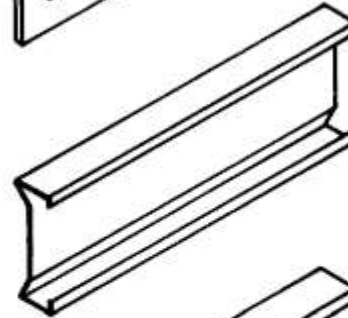

galvanised
Zed section
purlin or rail

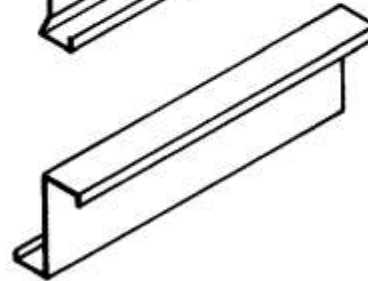

Steel section purlin and sheeting
rails to support sheet metal and
asbestos cement sheeting

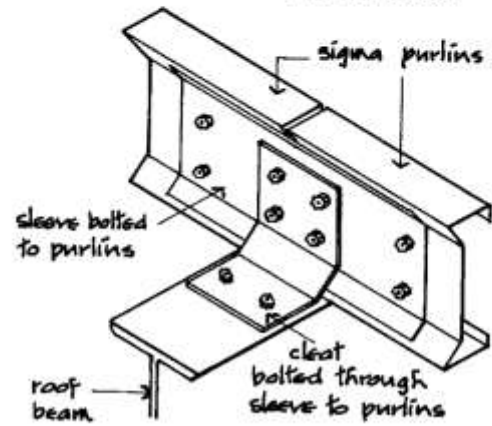
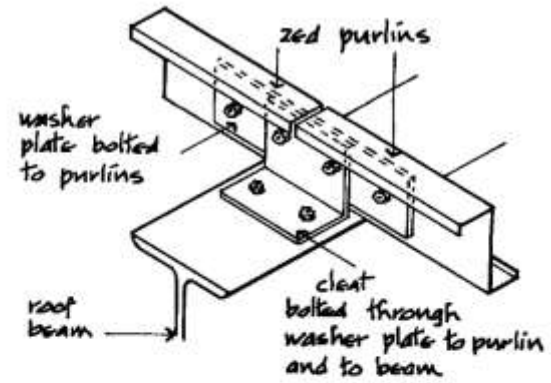

Washer plates and sleeves for continuity over supports

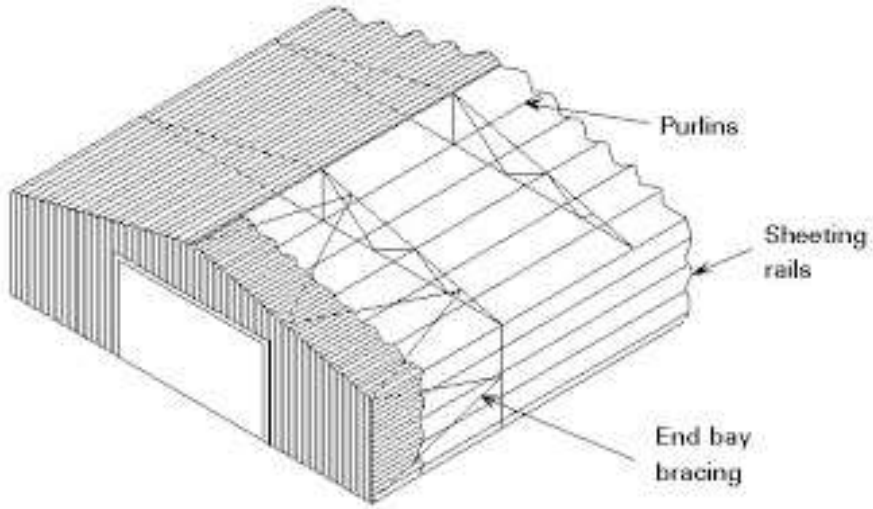

(a) Purlins provide lateral support to top chord of truss

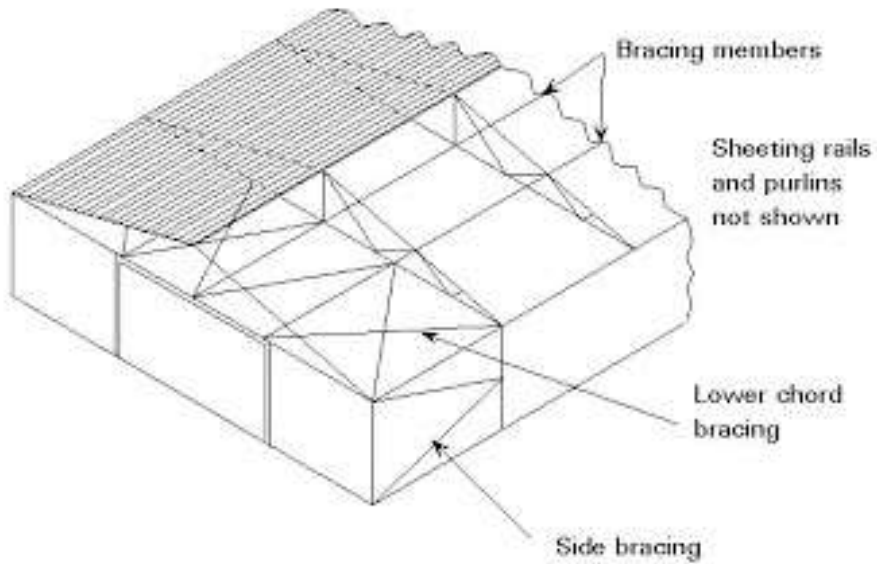

(b) Lower chord bracing system provides lateral support to bottom chord of truss



Figure 10 Lateral support for roof truss