



University of Sallahadin
College of Engineering
Electrical Engineering Dept.



Electrical CAD

Lecture Five

Object Properties, Dimensioning and Plotting

By :
Sarkar Jawhar
MSc in Electrical Engineering

Paper Preparation

- A4
- A3
- A2
- A1
- A0
- A5

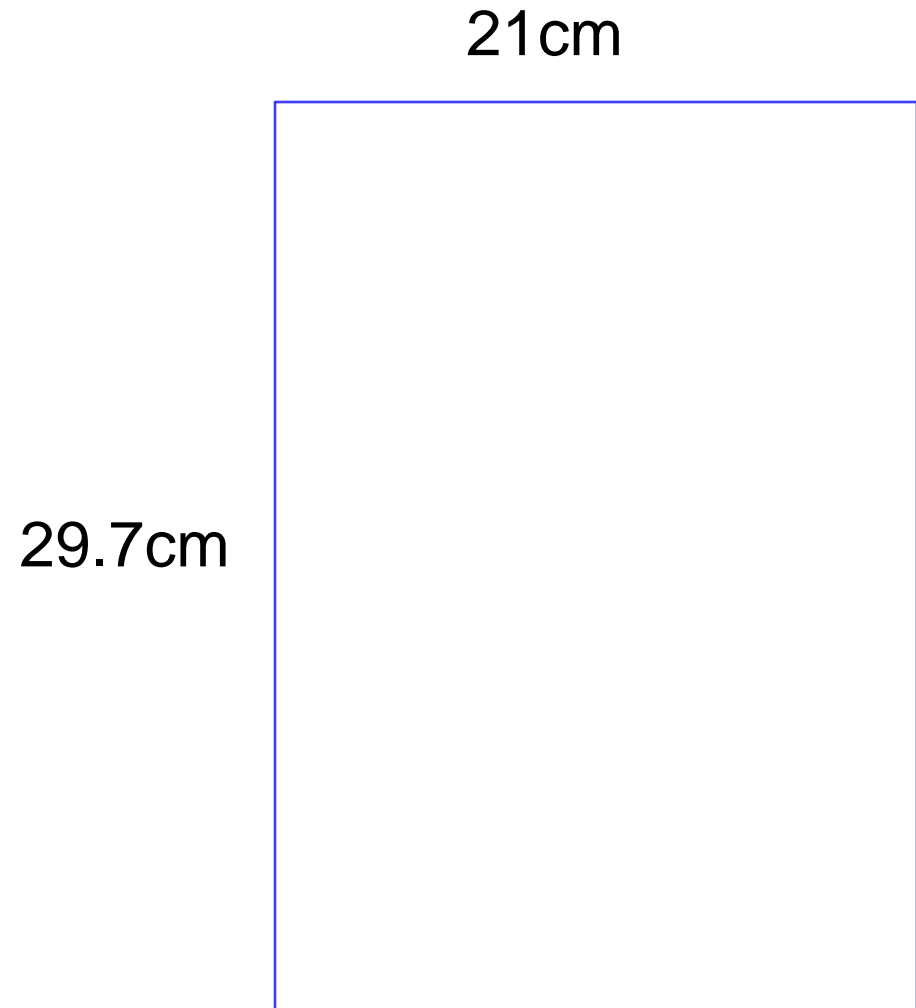

Paper Preparation

- Block Title: A4

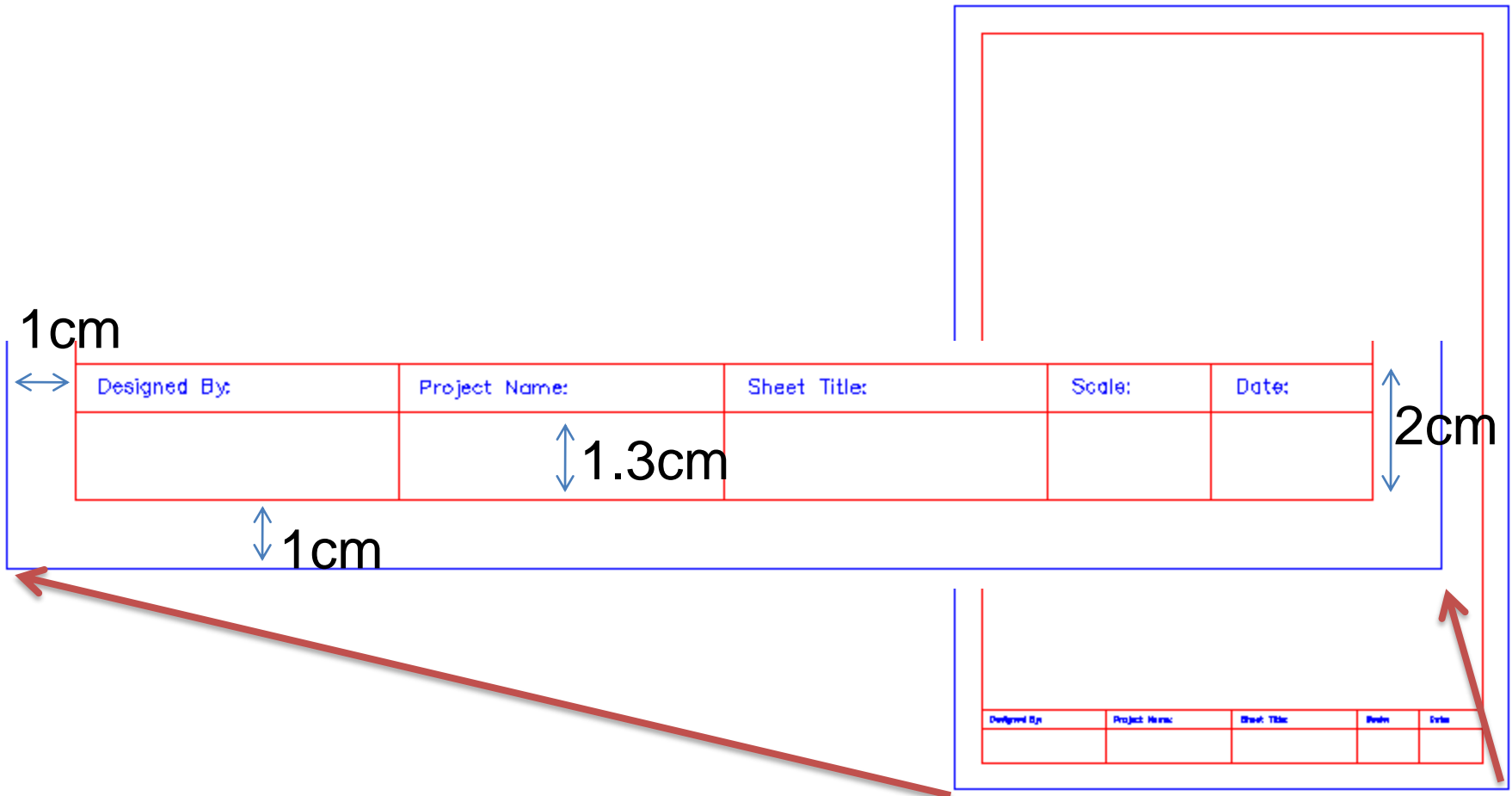

Paper Preparation

- Block Title: A3, A2, A1 & A0

The diagram illustrates the layout of a technical drawing sheet. A large rectangular area is outlined with a dashed line, representing the drawing area. Below this area are two tables. The first table is a revision table, and the second is a title block. Red arrows point from the top corners of the drawing area to the revision table and from the bottom right corner of the drawing area to the title block.

RevNo	Revision note	Date	Signature	Checked
-------	---------------	------	-----------	---------

Itemref	Quantity	Title/Name, designation, material, dimension etc			Article No./Reference	
Designed by		Checked by	Approved by - date	Filename	Date	Scale
					Edition	Sheet 1/?

Object Properties

- Objects color, line weight and line type could be modified using Object Properties.

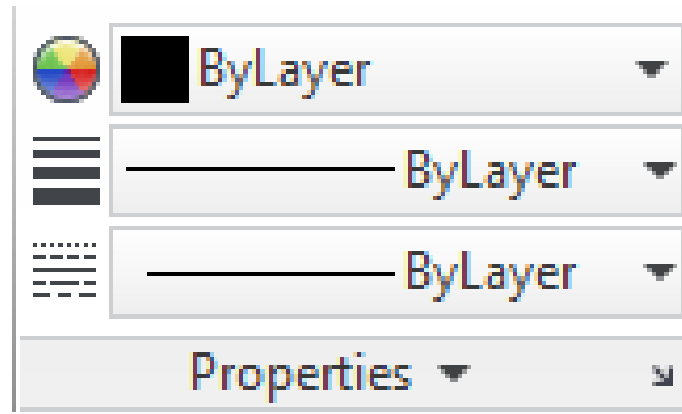

Object Properties

- Color

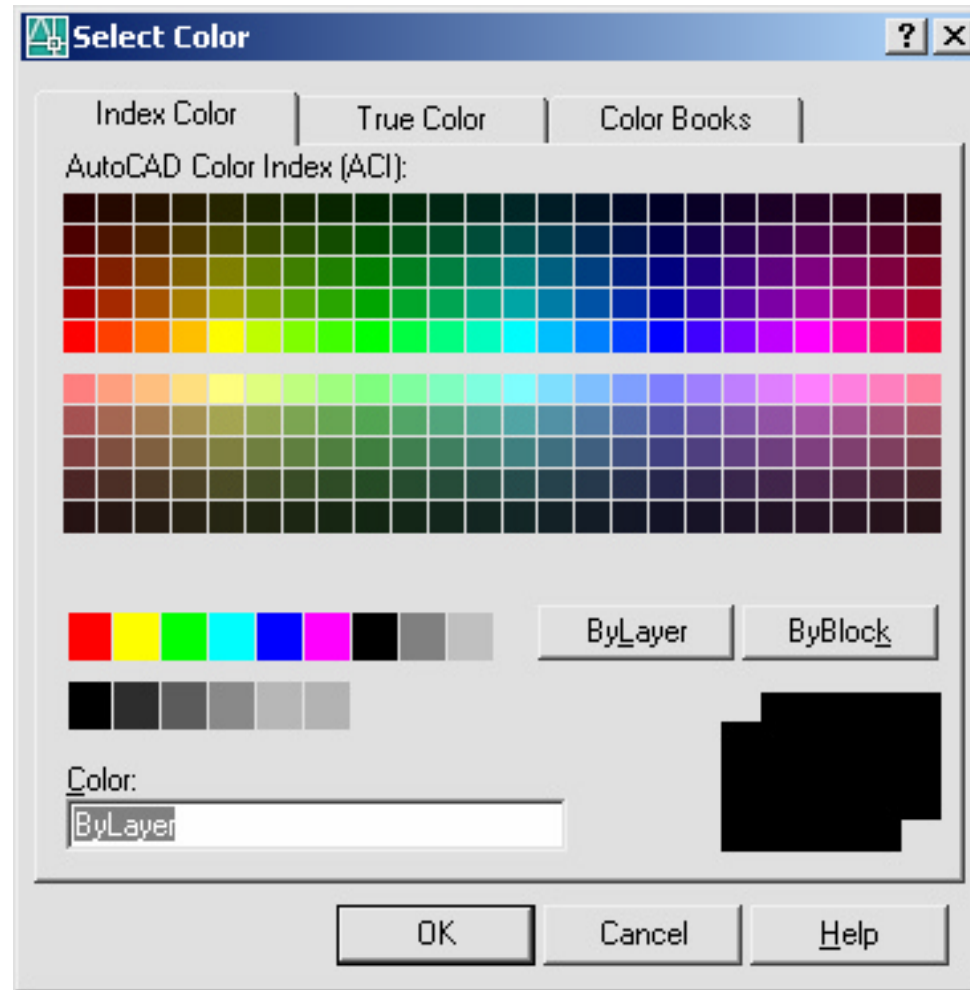

Object Properties

- Line weight

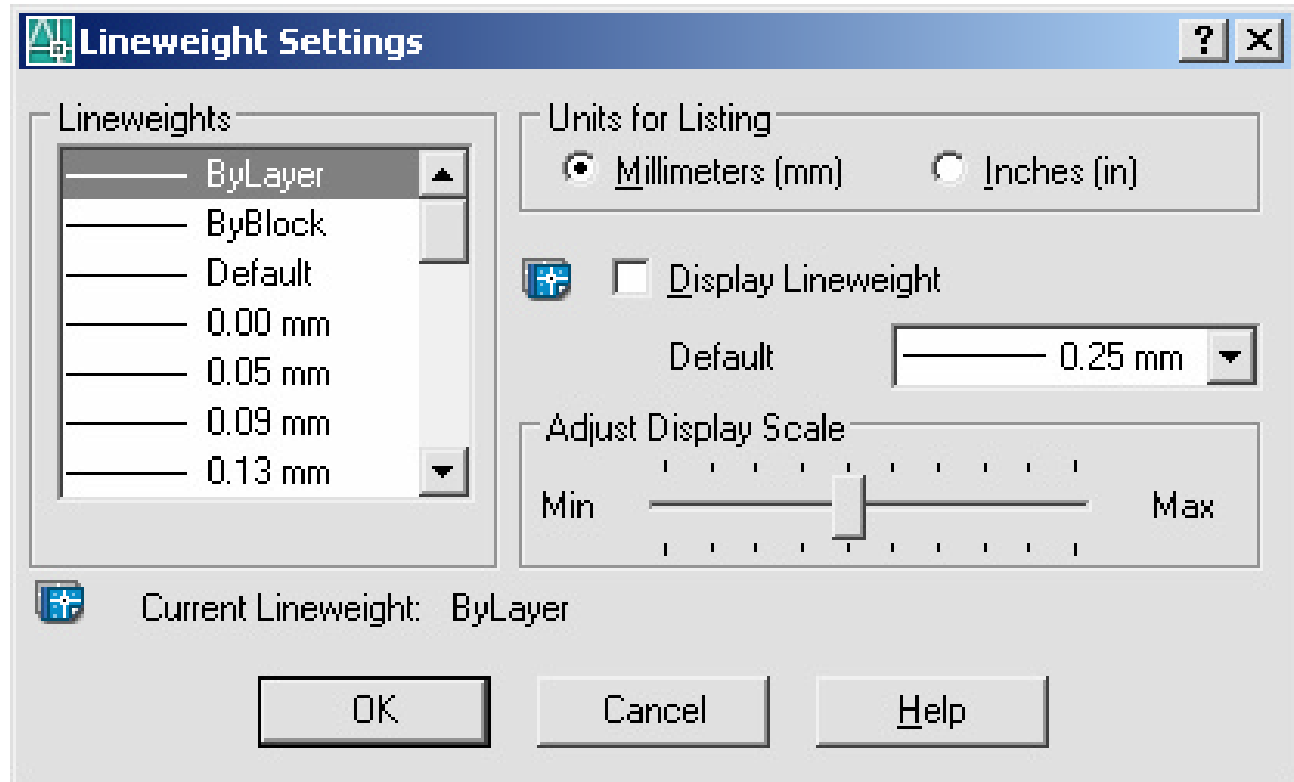





Object Properties

- Line types

Linetype Manager

Linetype filters
 Show all linetypes Invert filter
 Load... Delete
 Current Hide details

Current Linetype: ByLayer

Linetype	Appearance	Description
ByLayer		
ByBlock		
ACAD_ISO08W100		ISO long-dash short-dash
Continuous		Continuous

Details
 Name:
 Description:
 Use paper space units for scaling
 Global scale factor:
 Current object scale:
 ISO pen width:

OK Cancel Help

Linear Dimensioning

Creates linear dimensions.

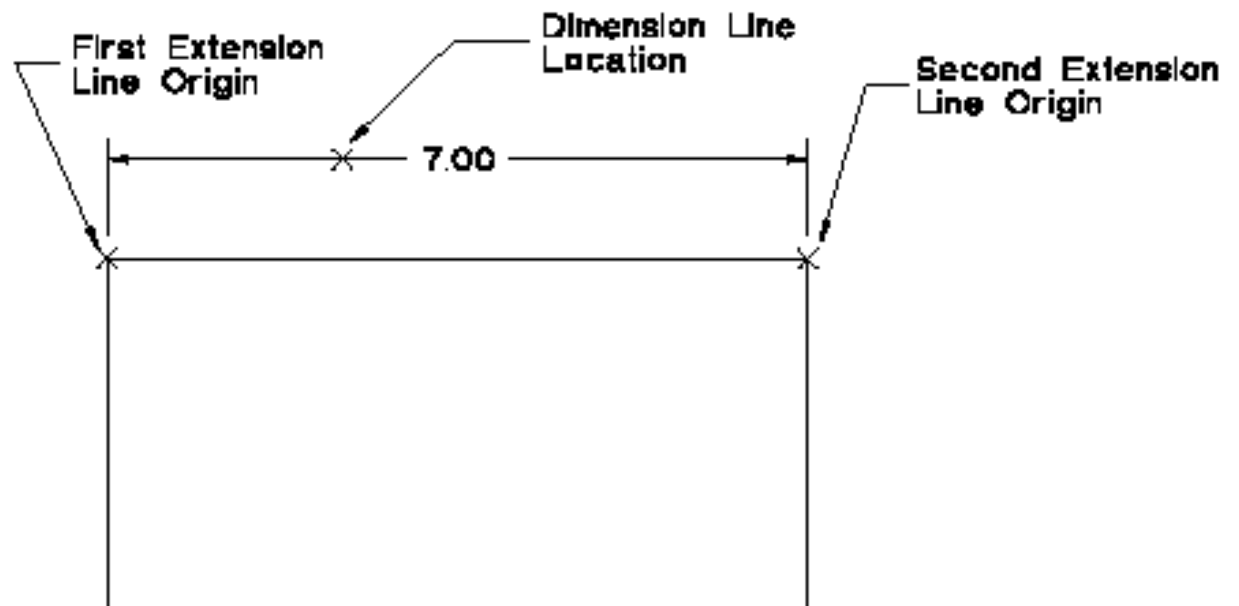
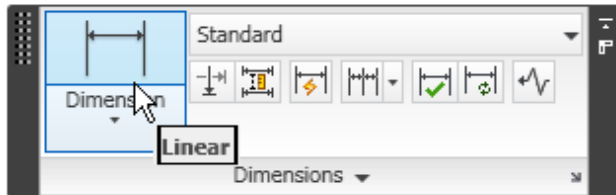

Aligned Dimensioning

Creates an aligned linear dimensions.

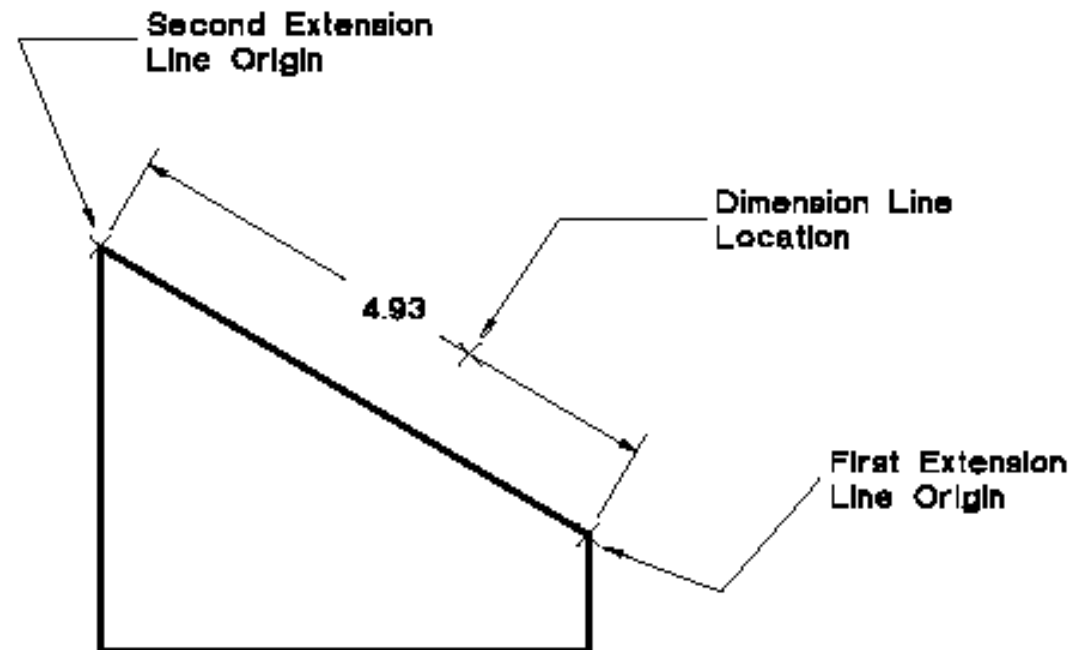
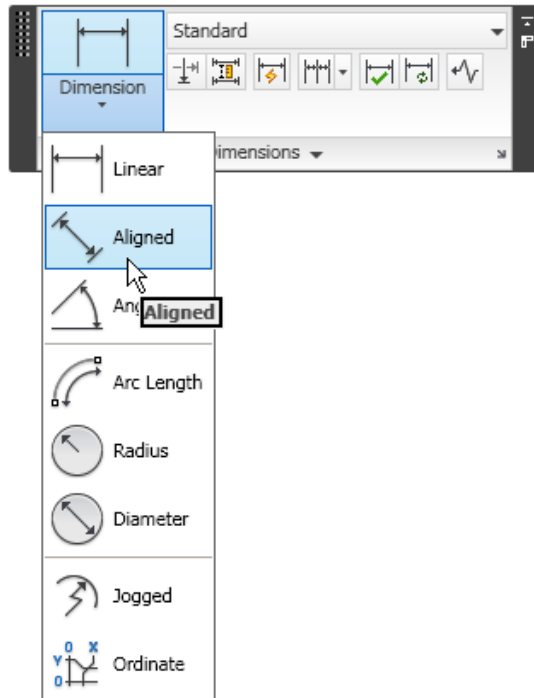

Radius Dimensioning

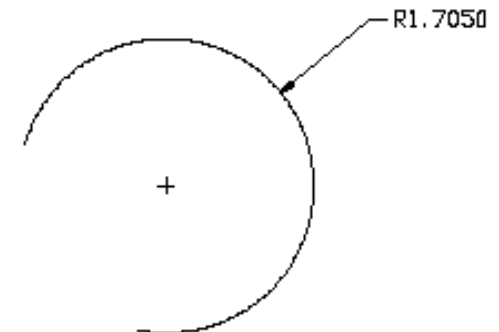
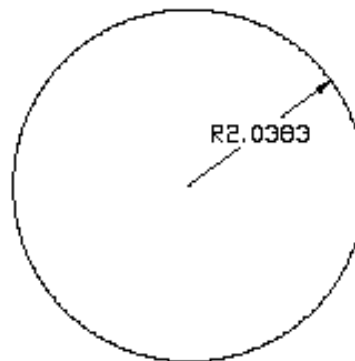
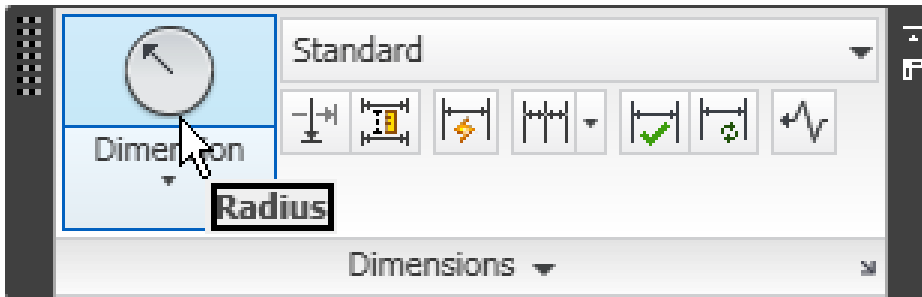

Diameter Dimensioning

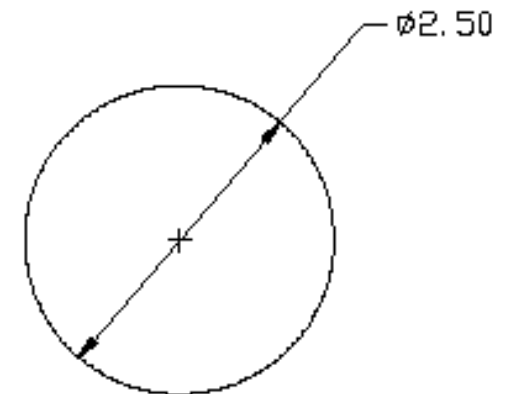
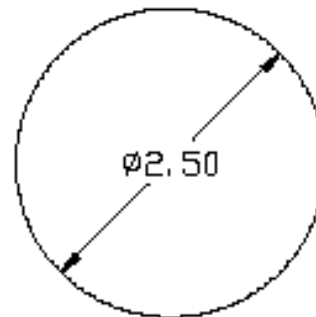
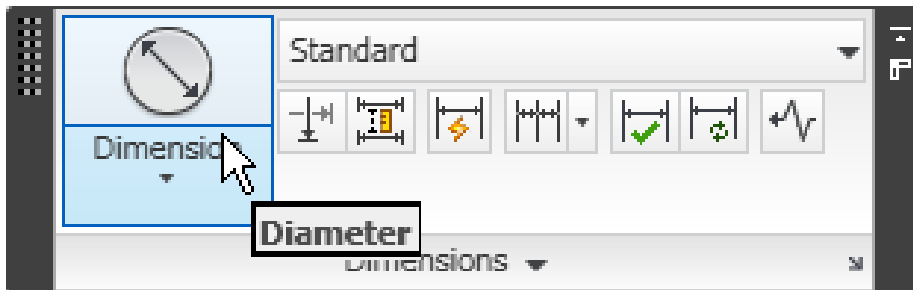

Arc Length Dimensioning

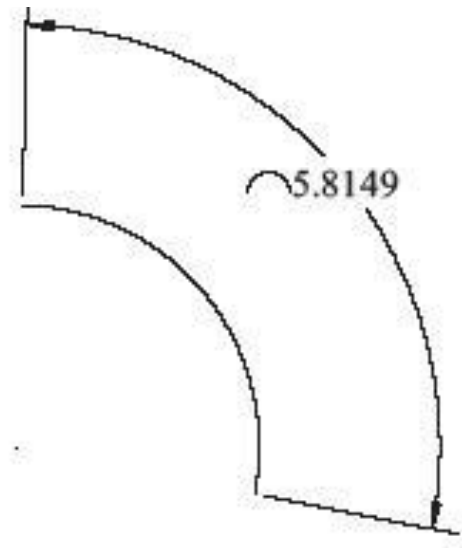
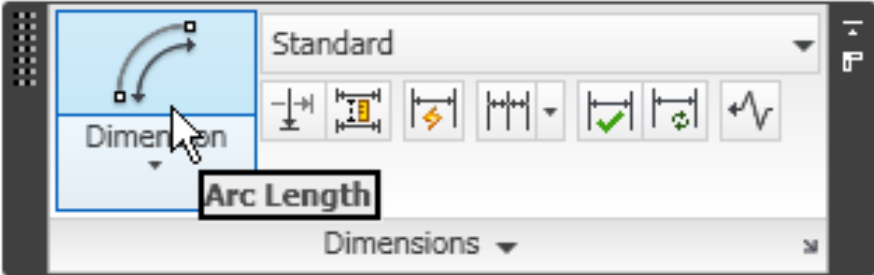

Angular Dimensioning

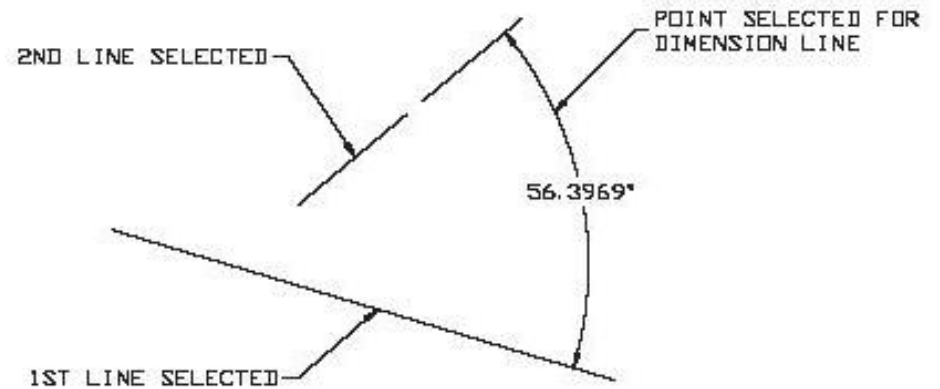
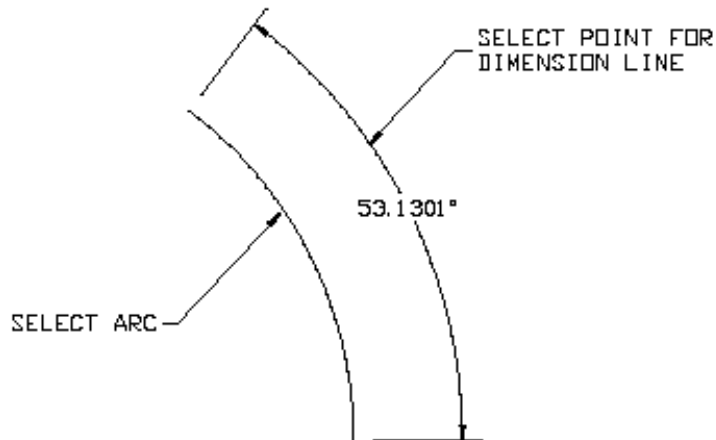
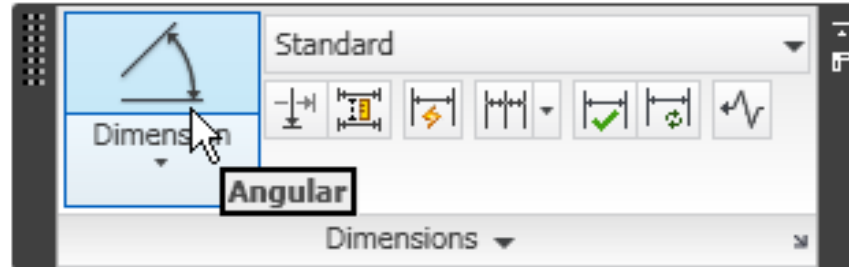

Dimension Style Manager

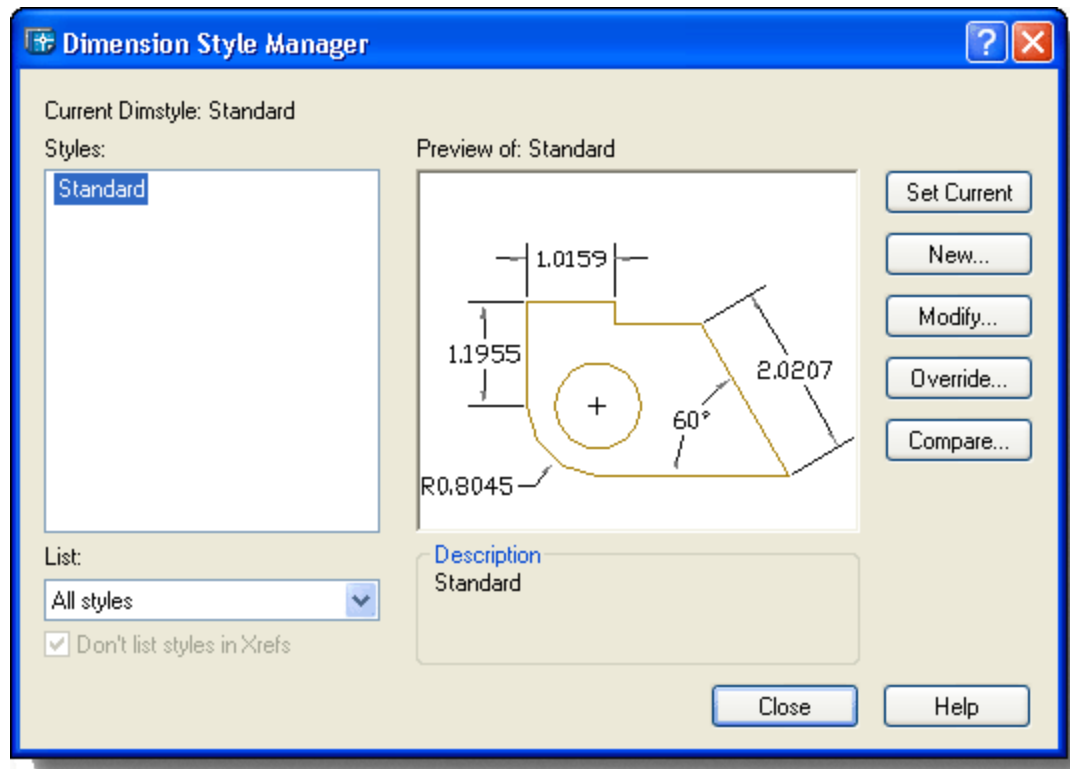

Dimension Style Manager

Modify Dimension Style dialog box – Lines selection

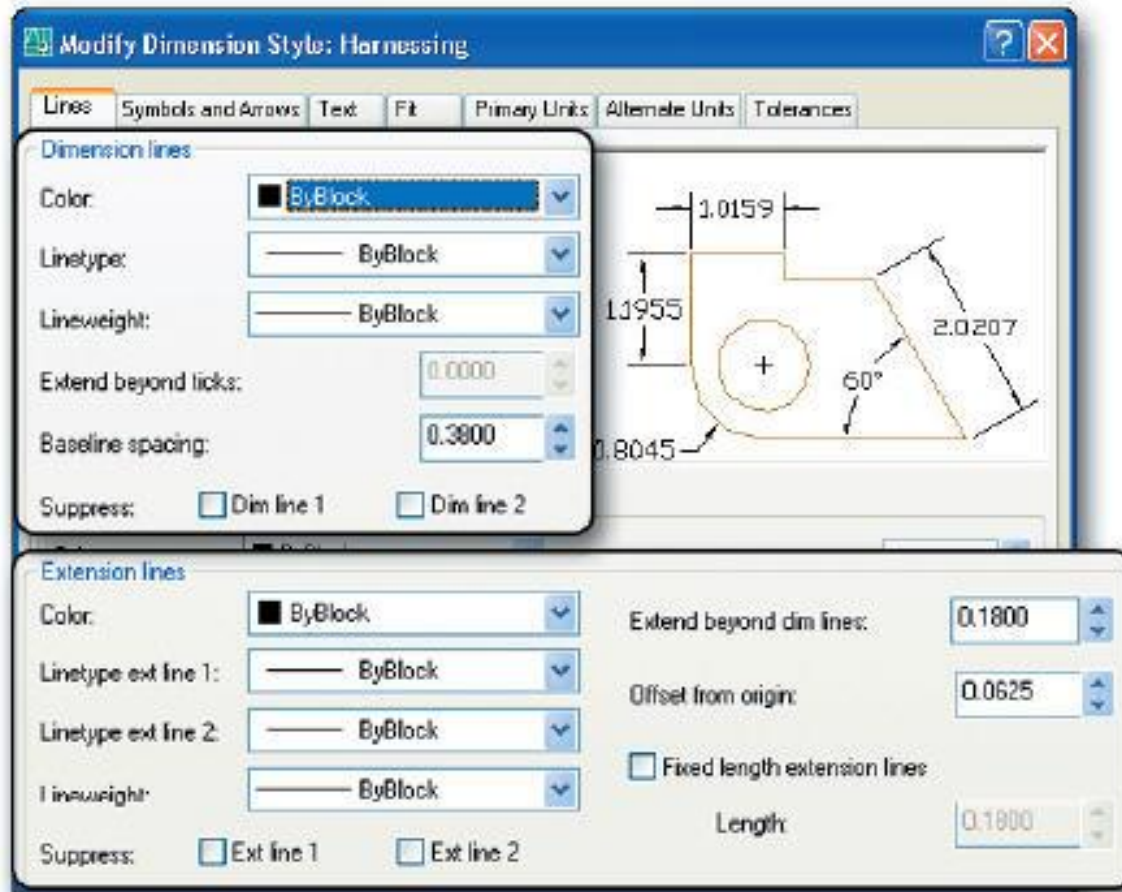

Plotting

- The drawing can be plotted from model space to any scale by specifying the plot scale in the plot dialog box.

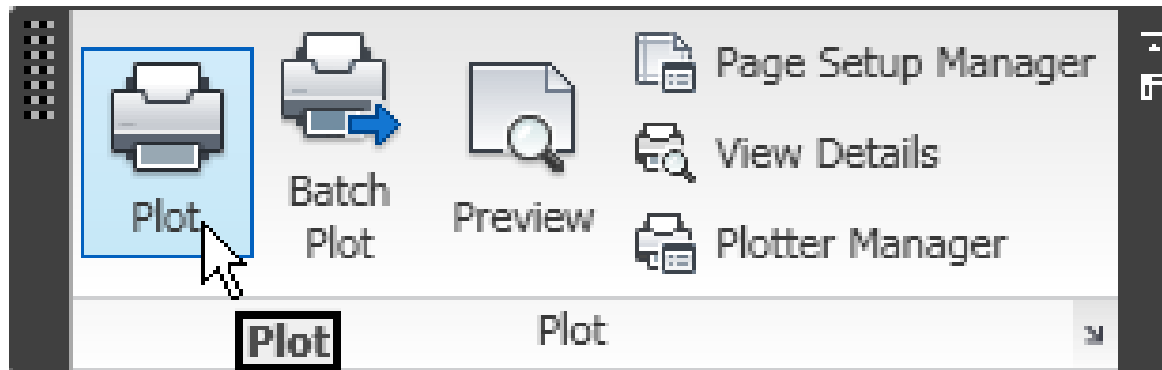

Plotting

Plot dialog box, not expanded

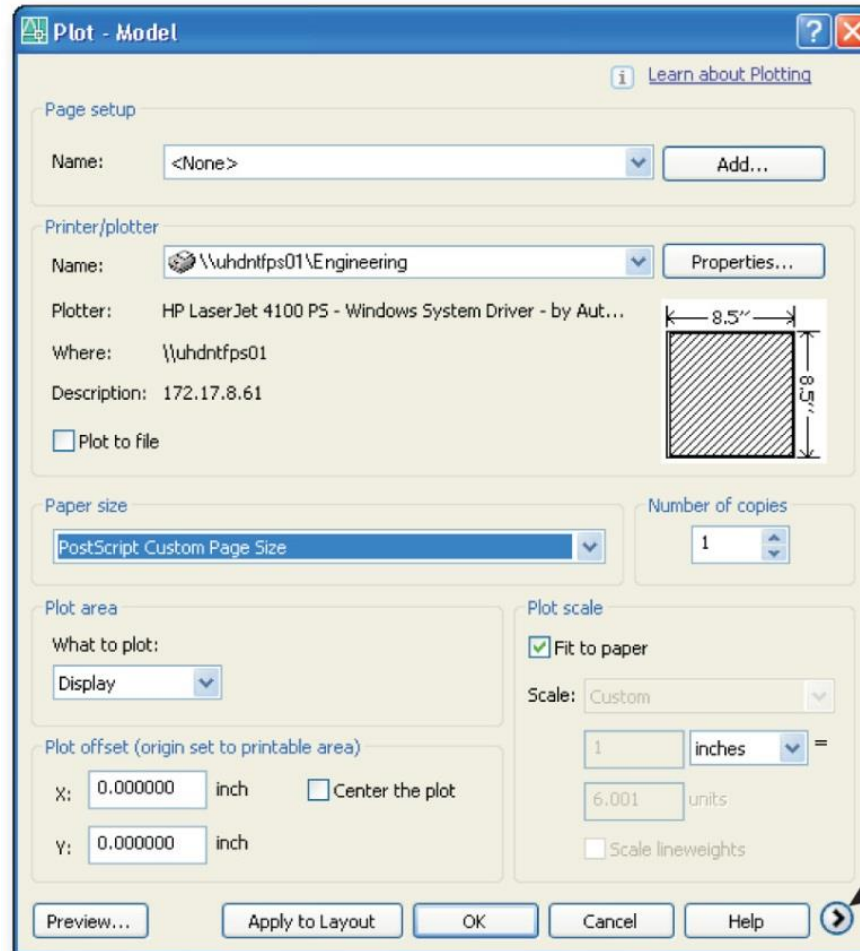

Plotting

Expanded Plot dialog box with additional options

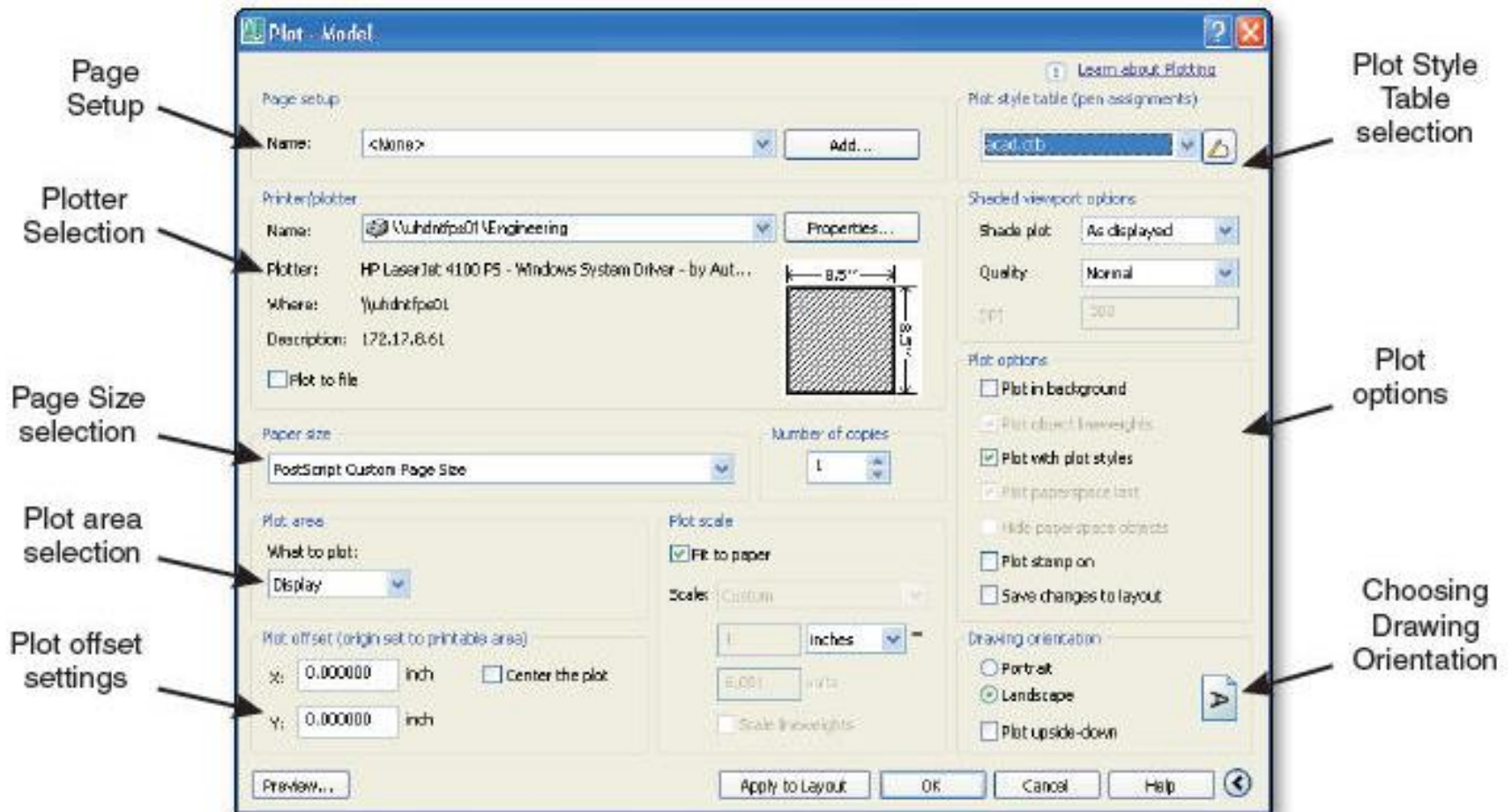

Plotting

Plot preview

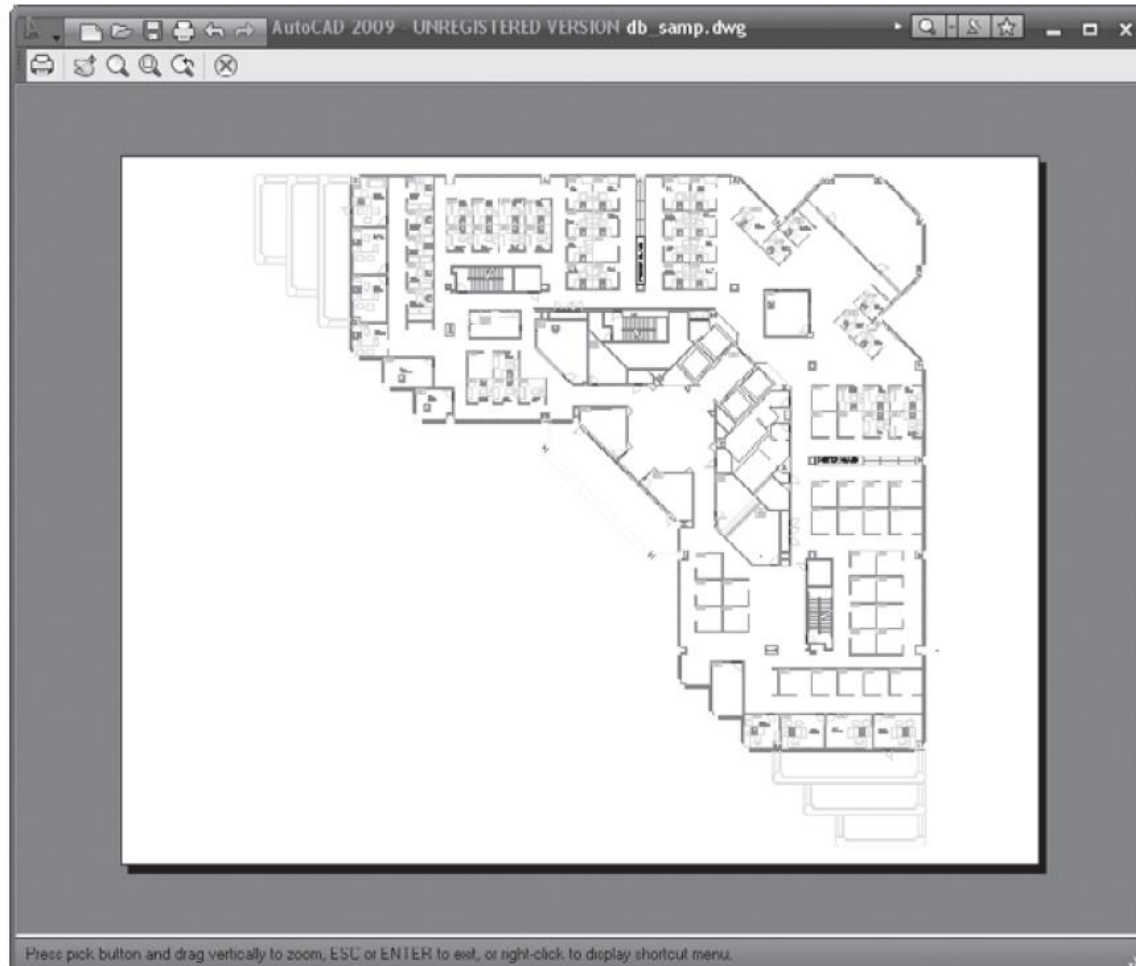

Assignment

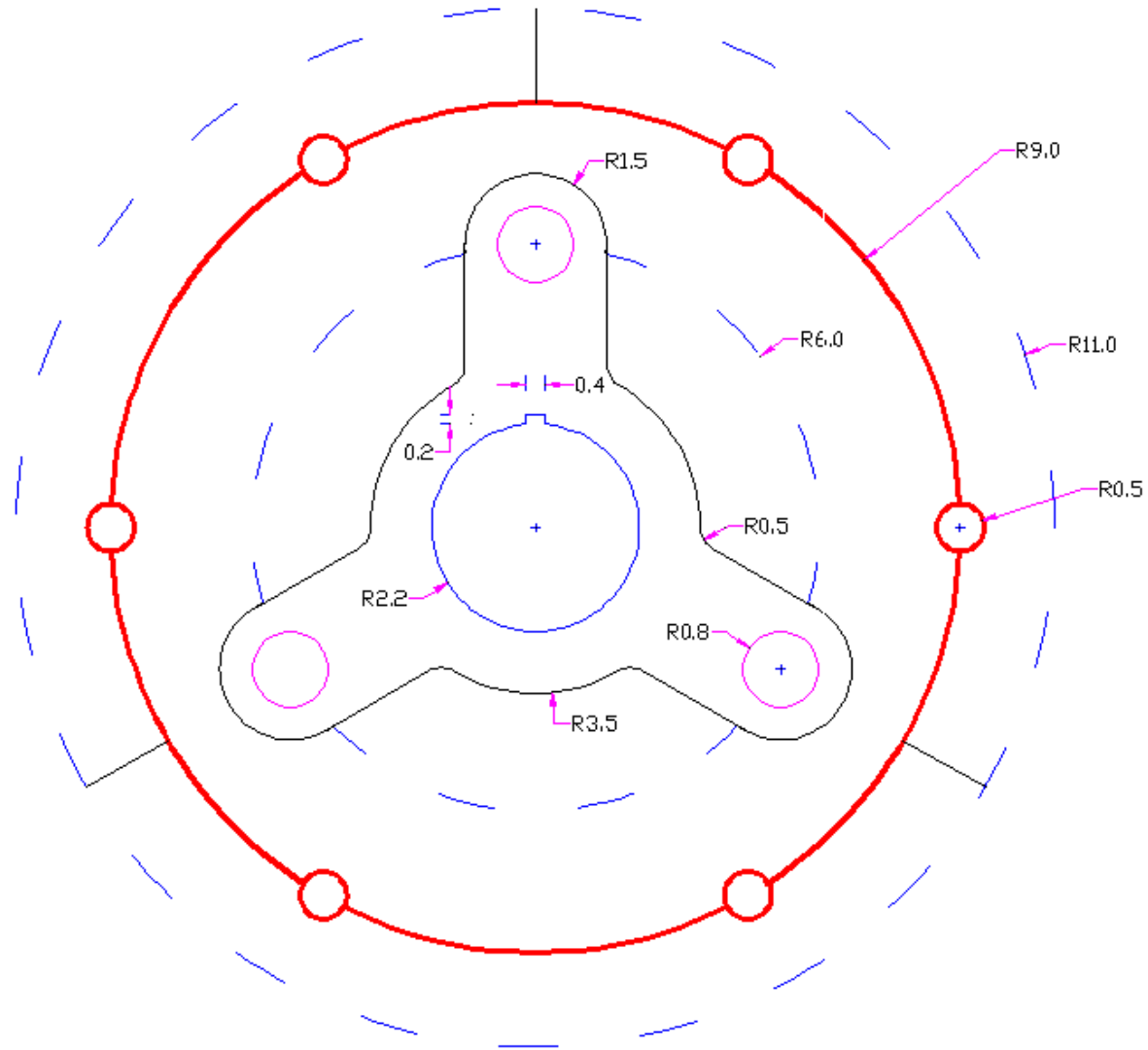

Questions and Thank you

*Thank
you*