



Salahaddin University-Erbil
College of Engineering
Architecture Department

Architectural Presentation & Perspective

Question Bank

**Lecturer: Dr.Zaynab Abdulrazzaq Yasir
2022-2023**

-Demonstrations

-Perspective Terminology

-Examples

- Students works

- Q1. What is the Station Point (S.P)?
- Q2. What is the Vanishing Points(V.P)?
- Q3. What is the Cone of vision (CV)?
- Q4. What is the Horizon Line (HL)?
- Q5. What is the Picture plane (PP)?
- Q6. What is the Ground Plane(GP)?
- Q7. What is the Center Line [of Vision] (CL or CLV)?
- Q8. What is the Center of vision(CV)?
- Q9. What does it mean to see things in perspective?
- Q10. What is perspective in design?

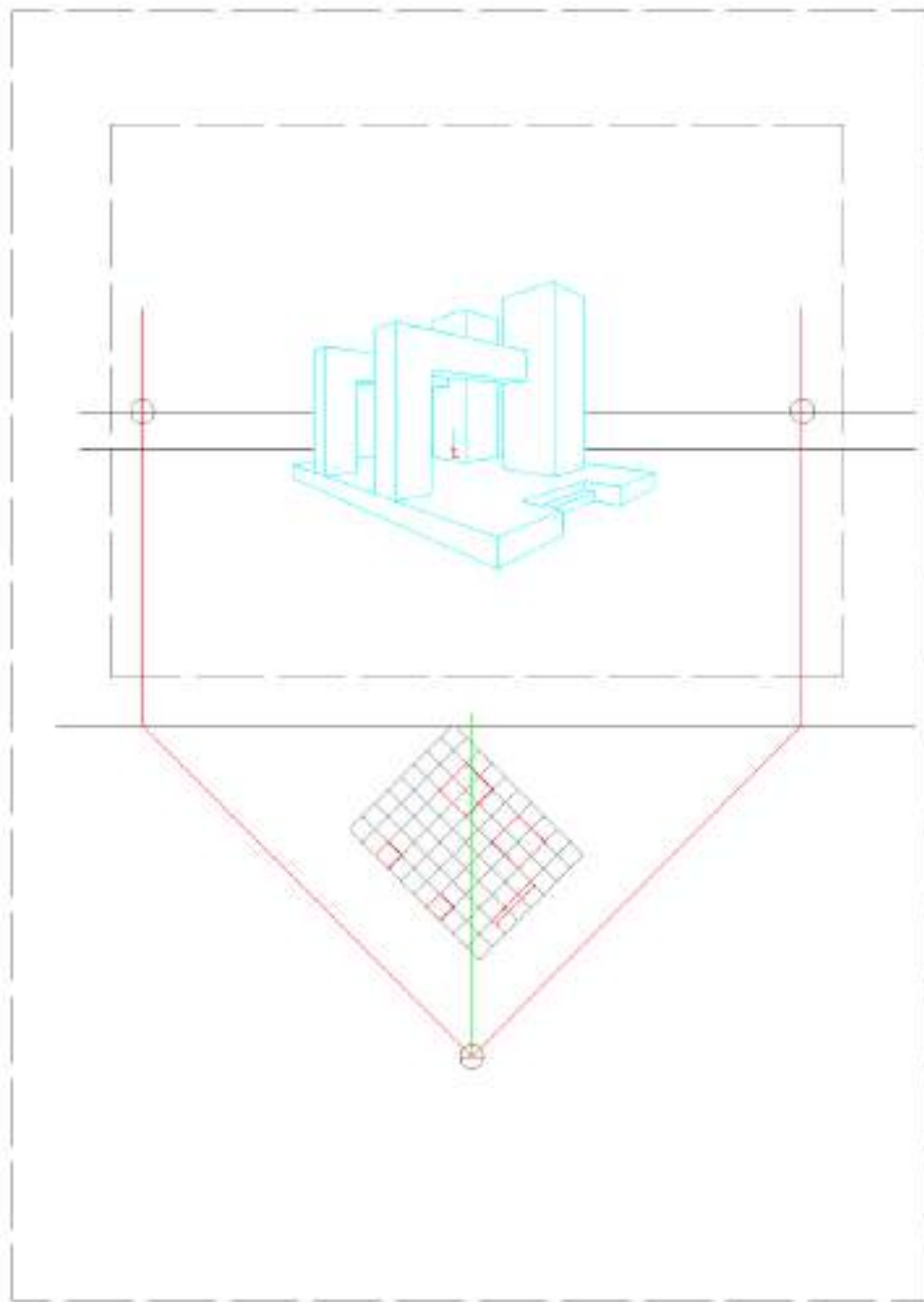

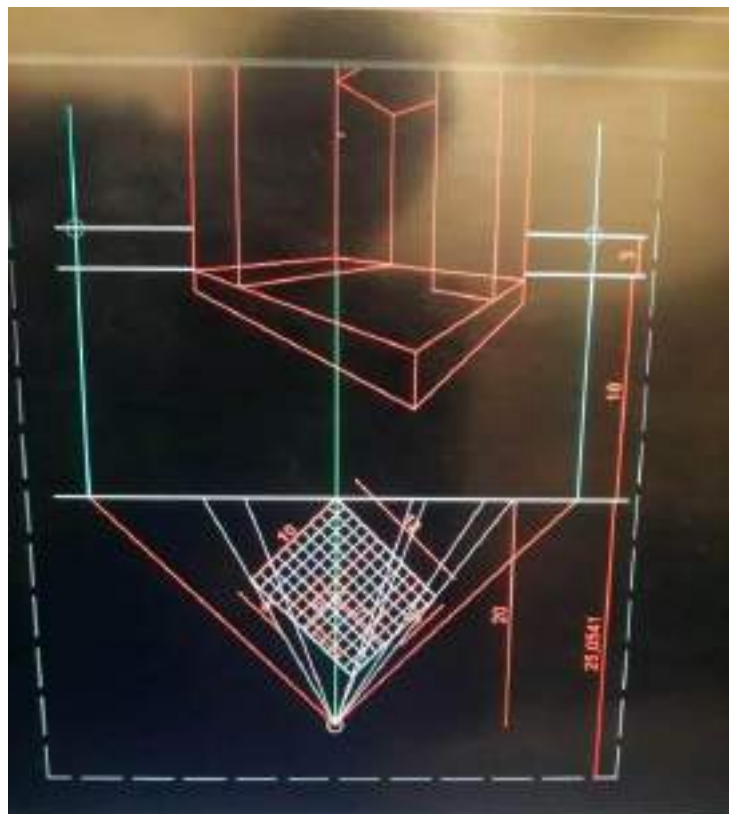
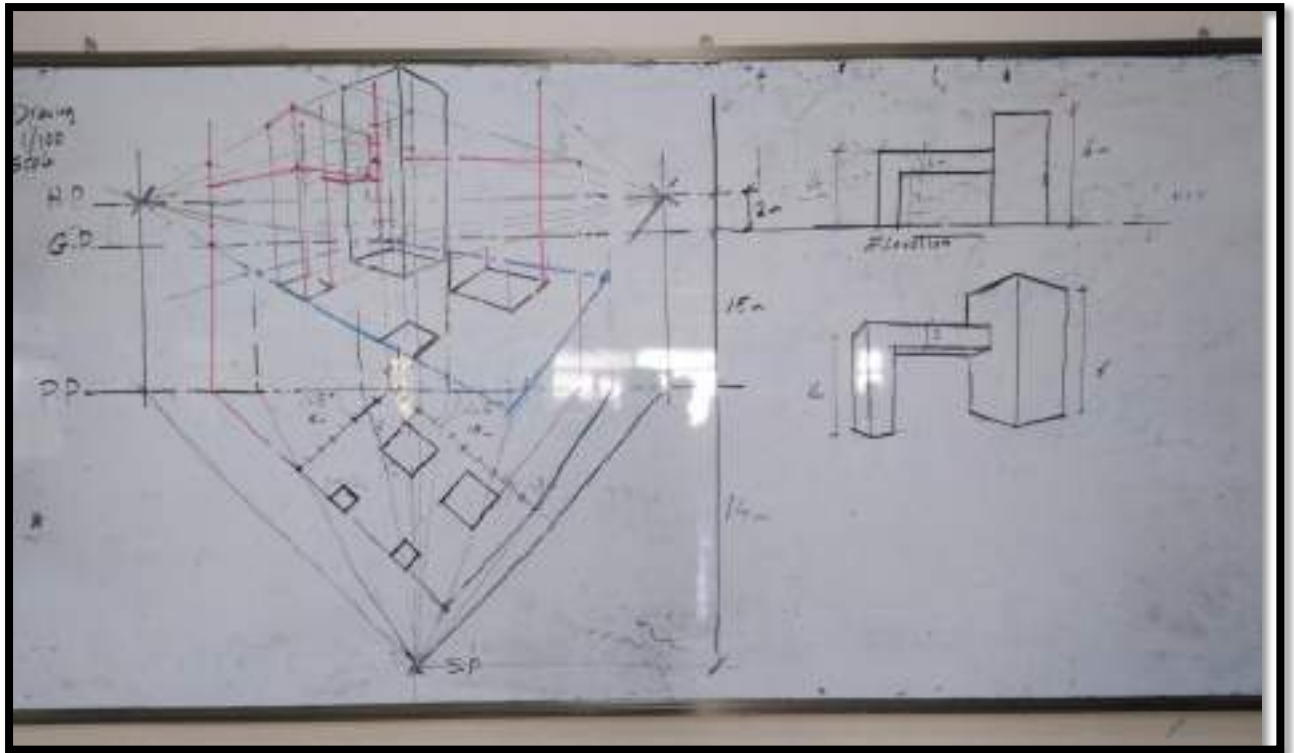

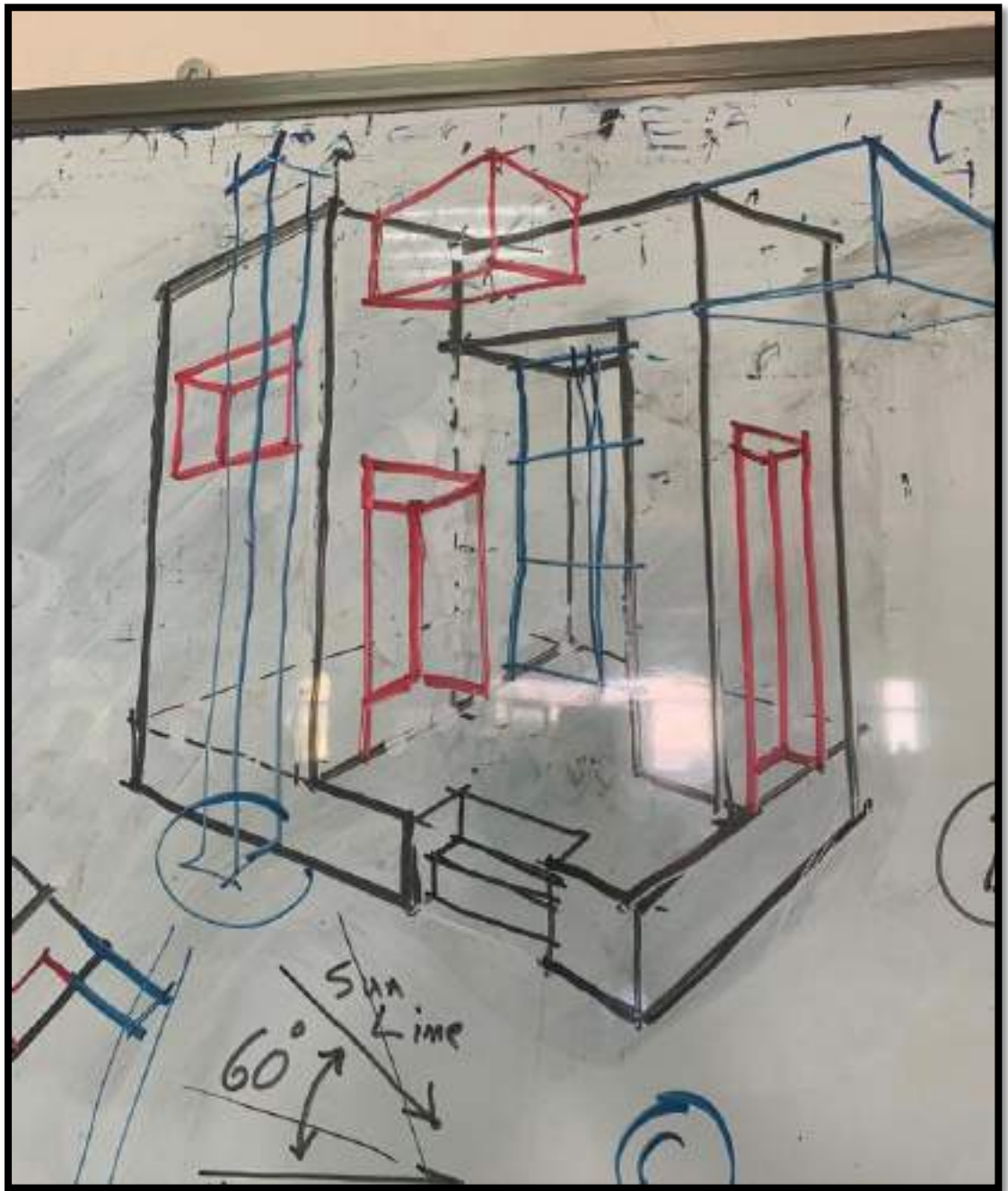





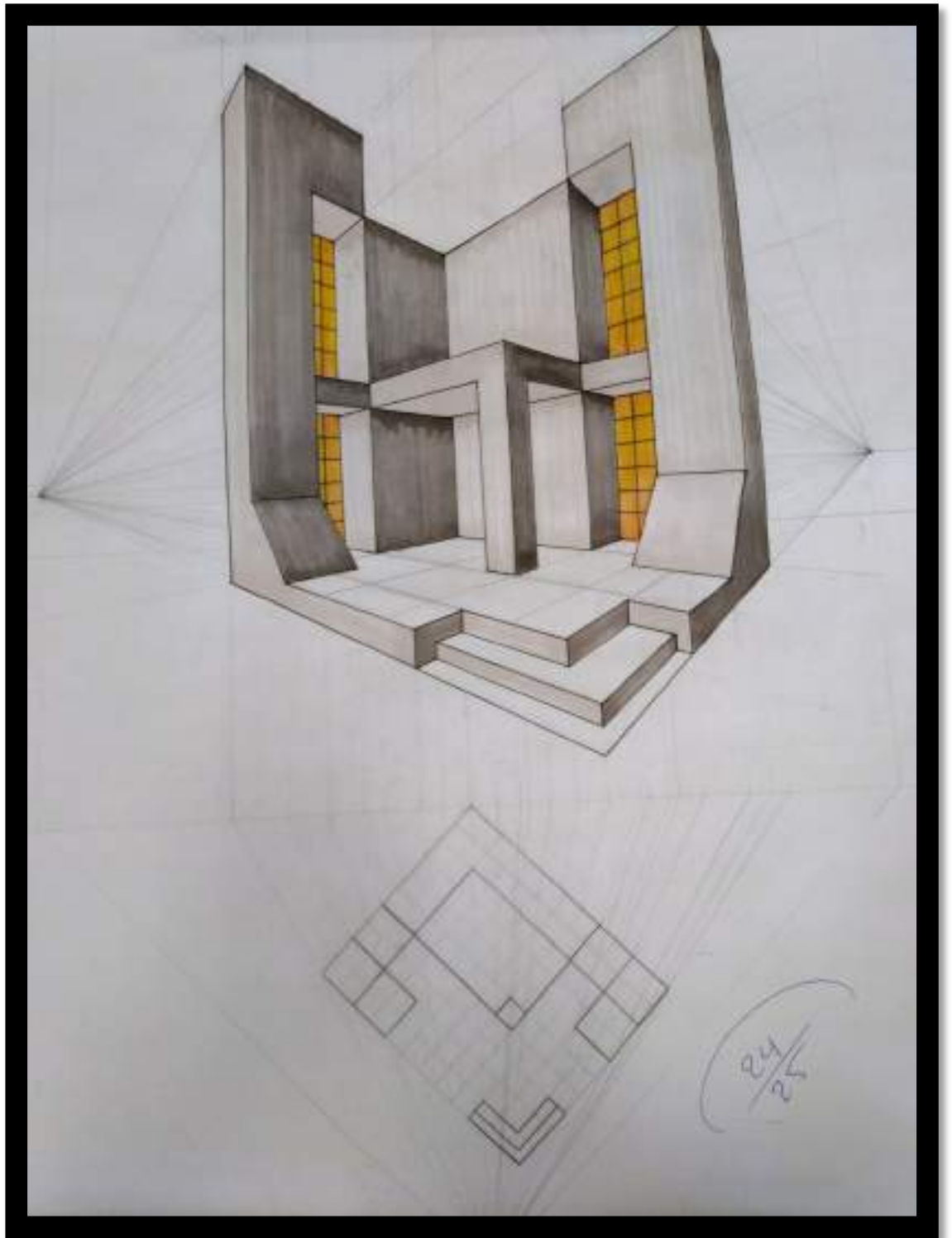

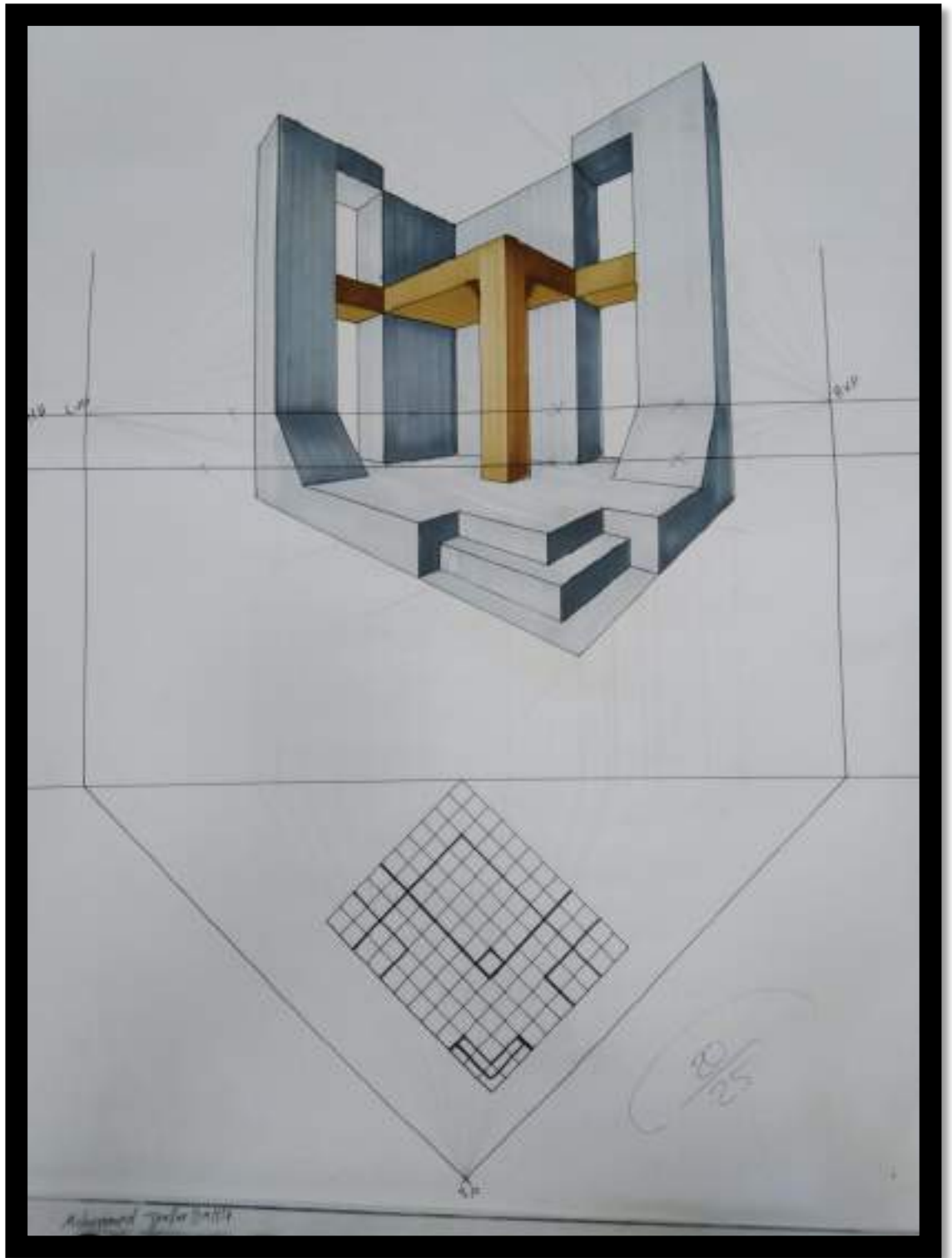



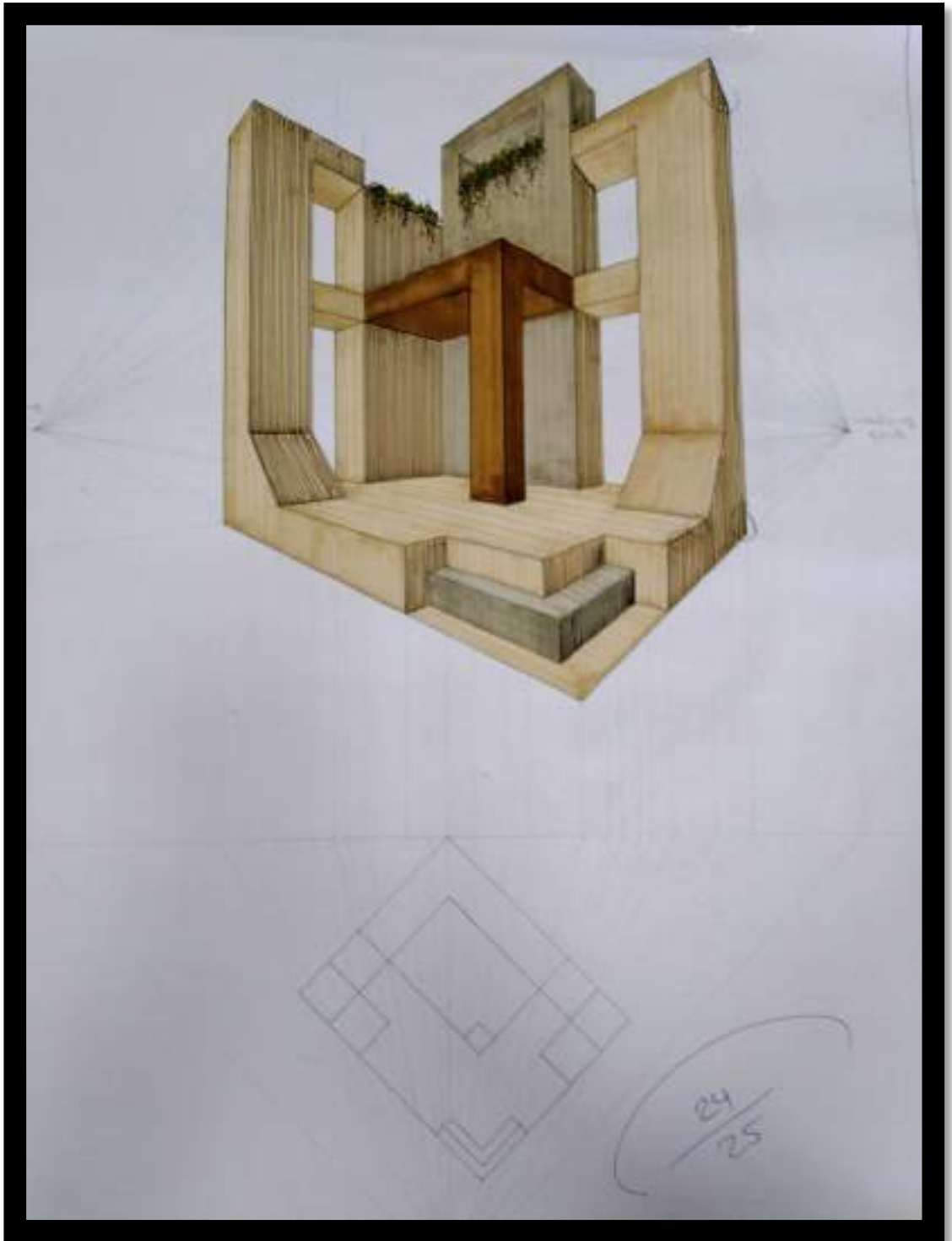



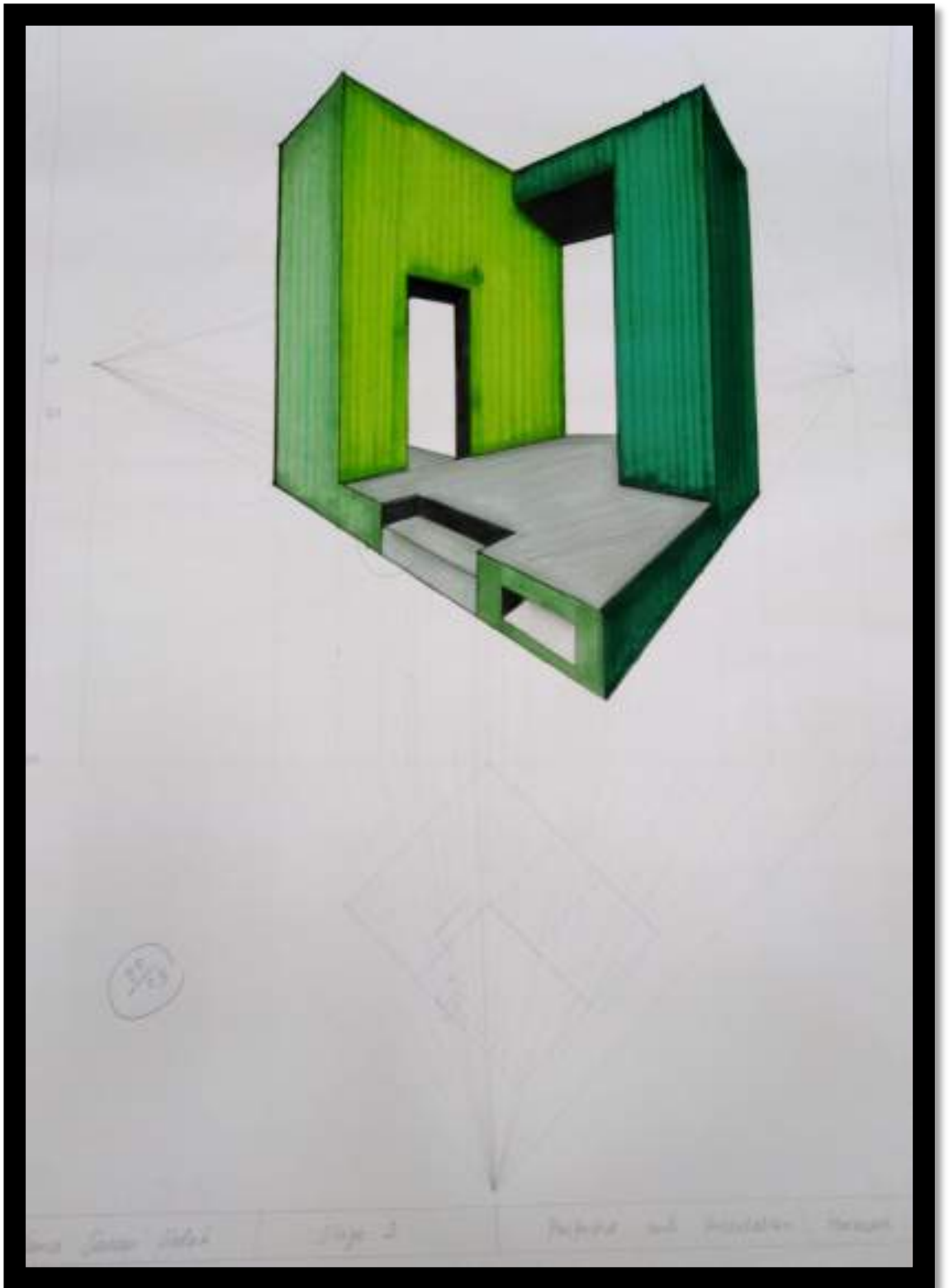

Handwritten text, possibly a name or title, located at the bottom left of the page.

Handwritten text, possibly a page number or date, located at the bottom center of the page.

Handwritten text, possibly a description or title, located at the bottom right of the page.



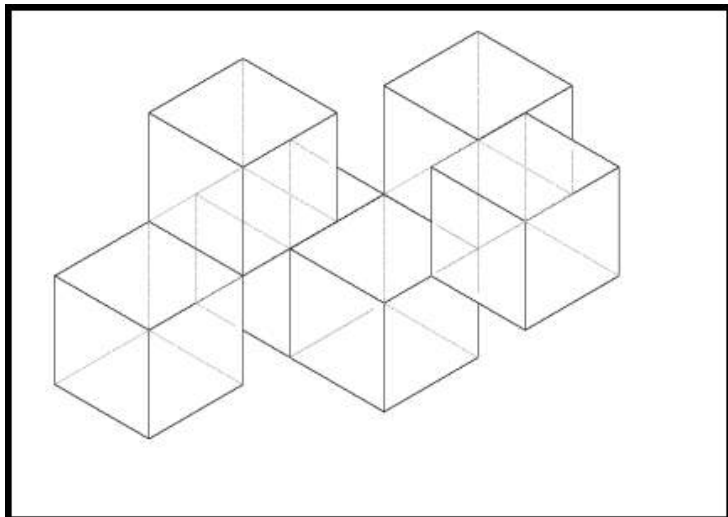
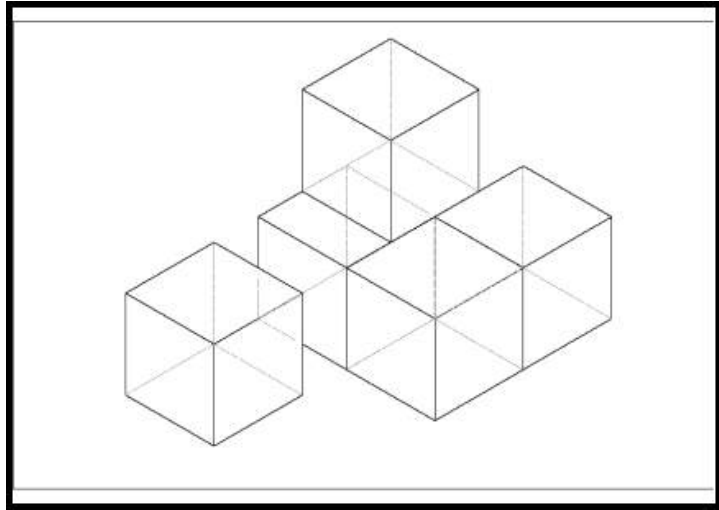
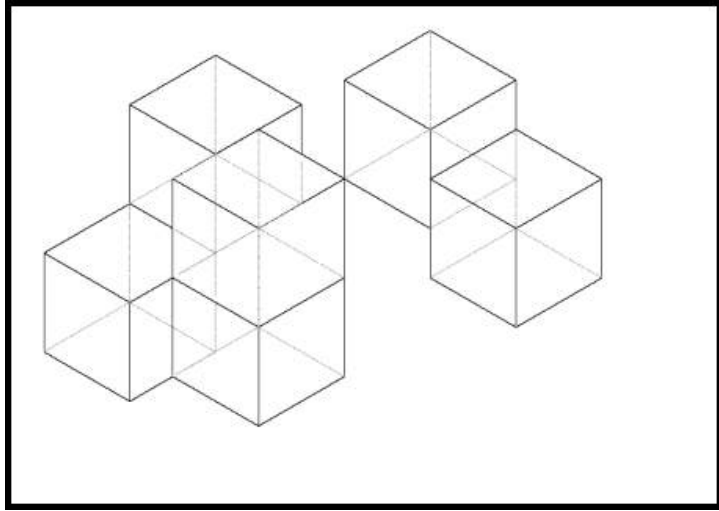

Q11. How to draw an arch in 2 point perspective

Q12. How do you draw an arch in perspective?

Q13. What is used to draw arcs?

Q14. What are the different methods for drawing an arch?

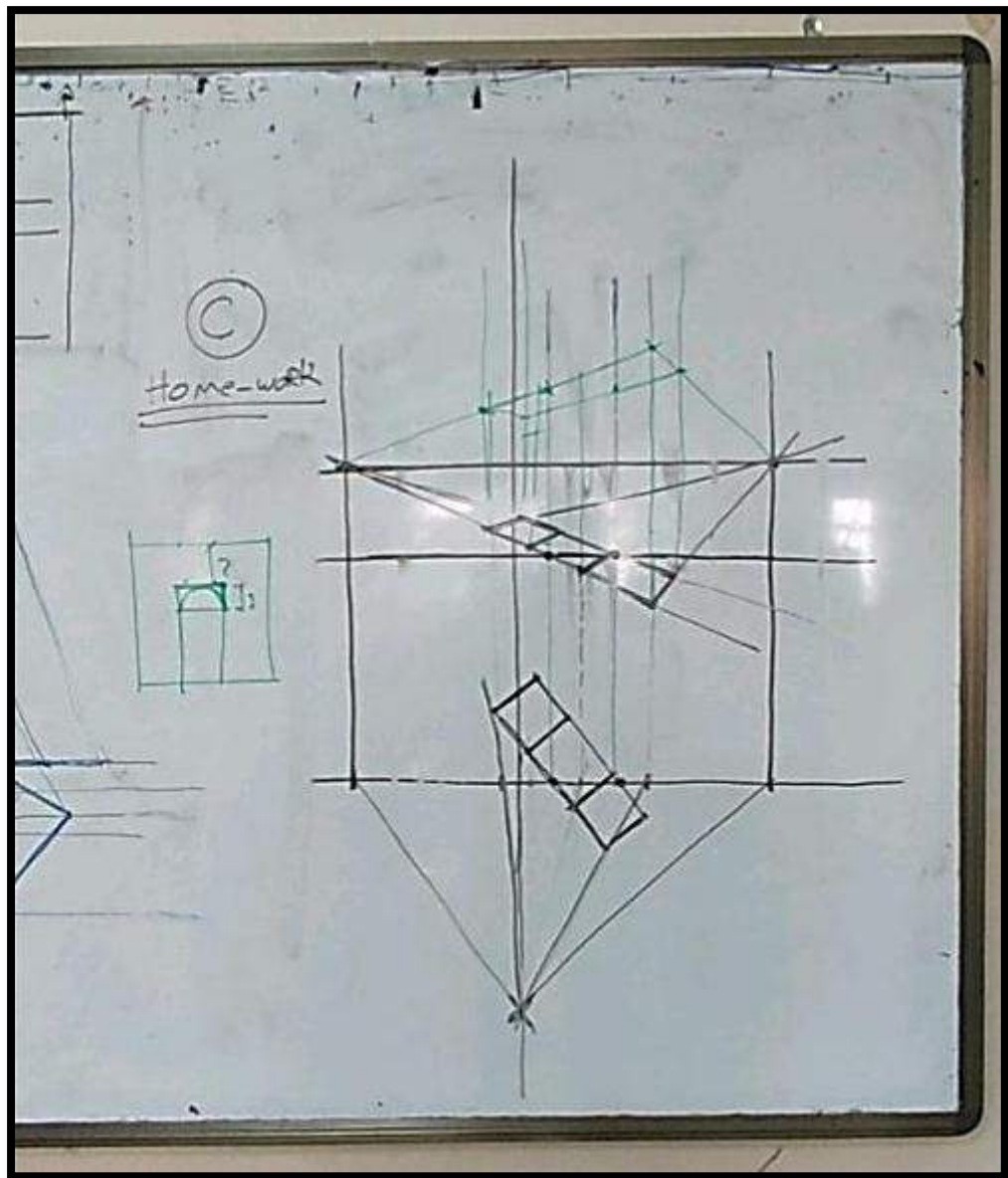

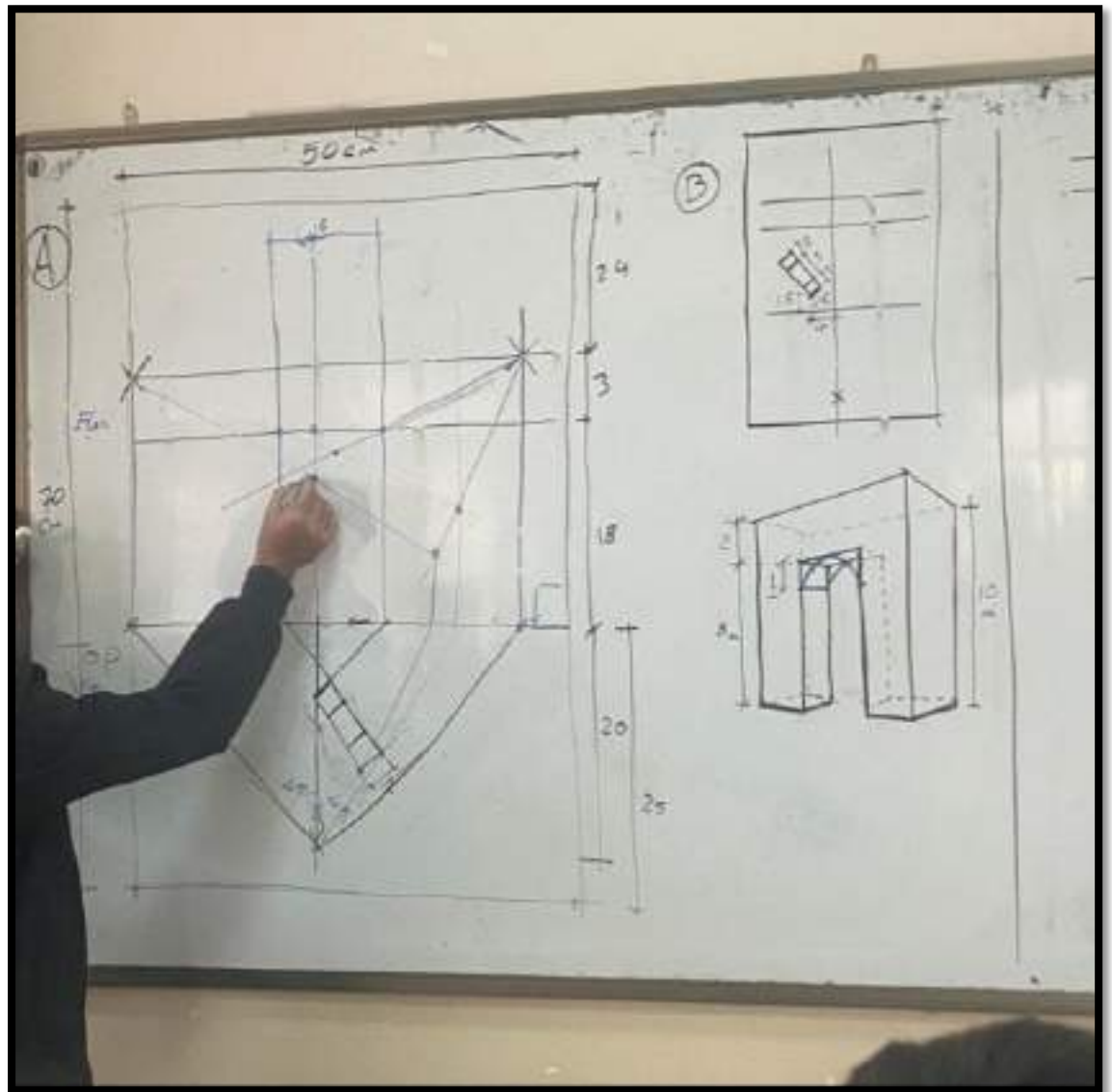



Sketch of a structure



LVP
GL

RVP
H

FP



24/25

SP

Name: Muhammed Issaoui, Ameer

Stage: 2

Date: 27.3.2023

Subject: Perspective and Presentation

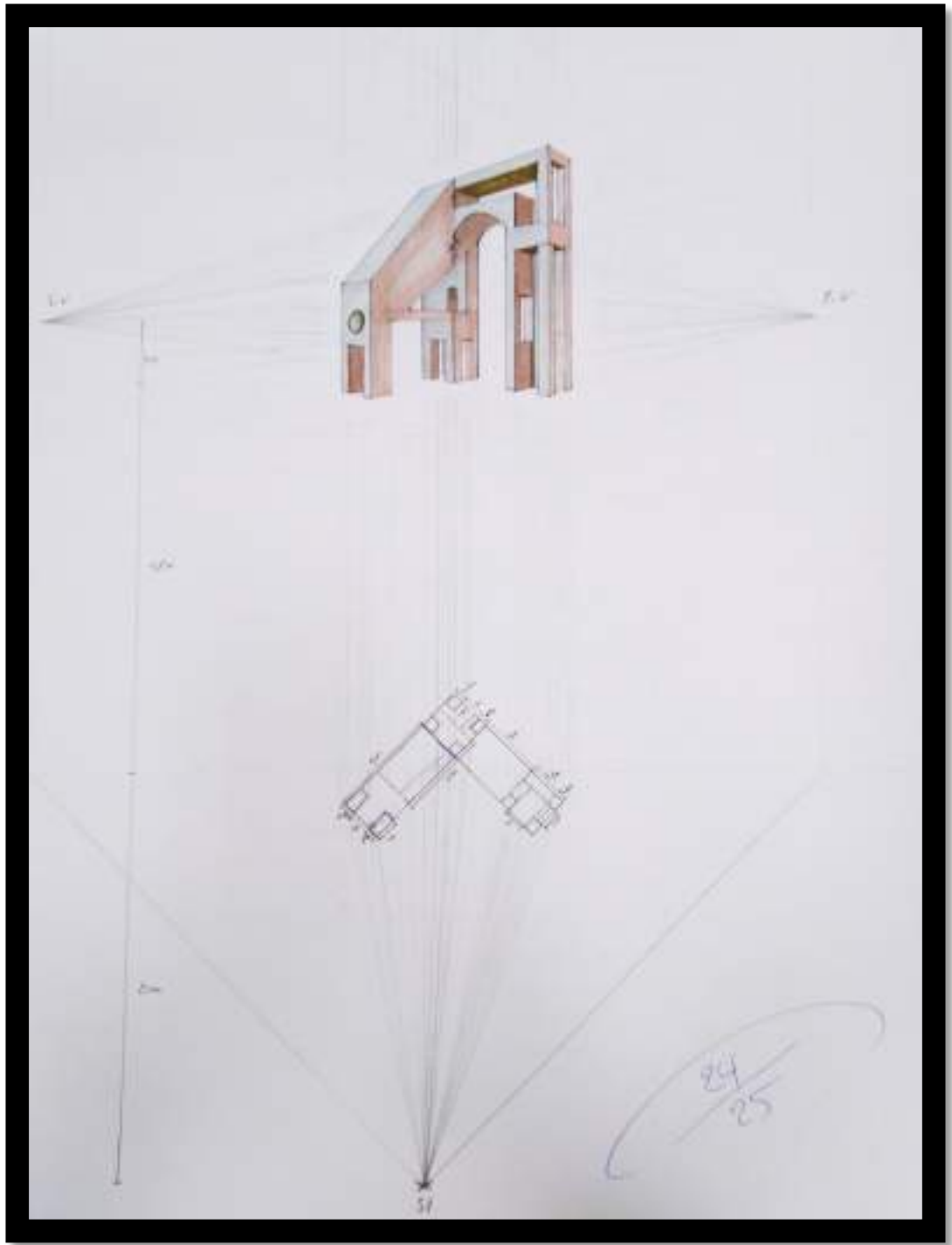

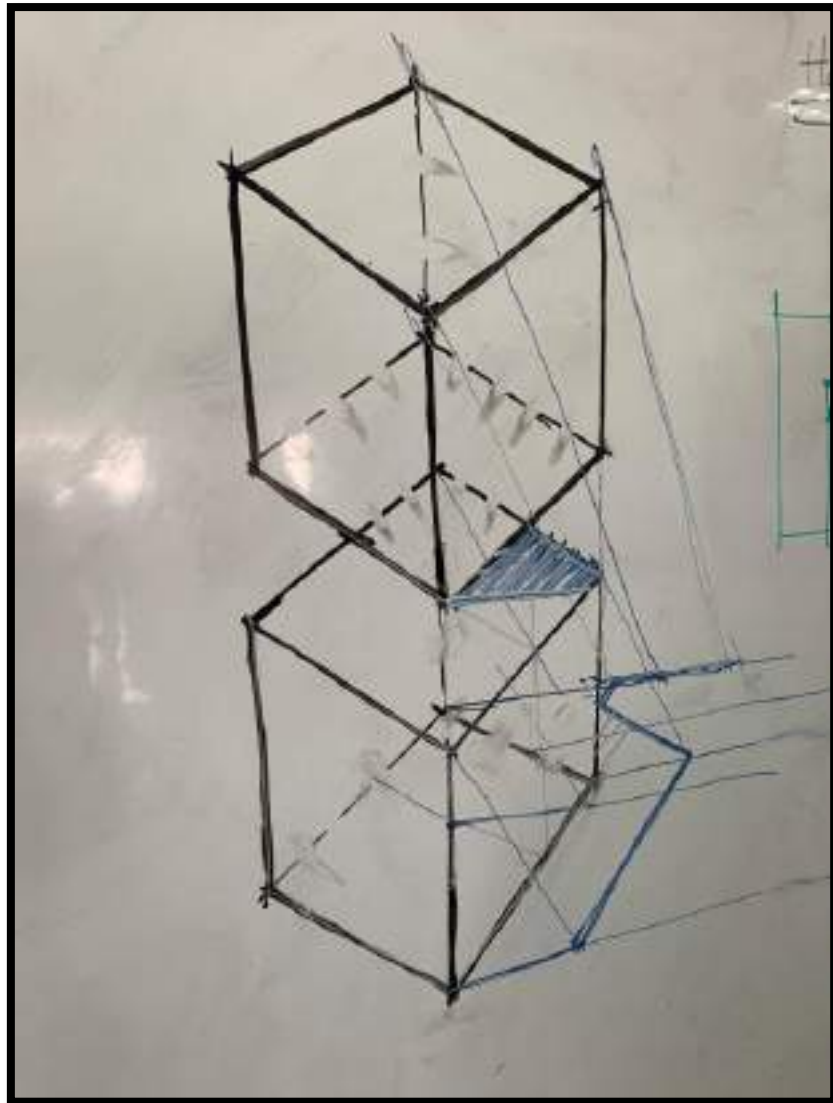
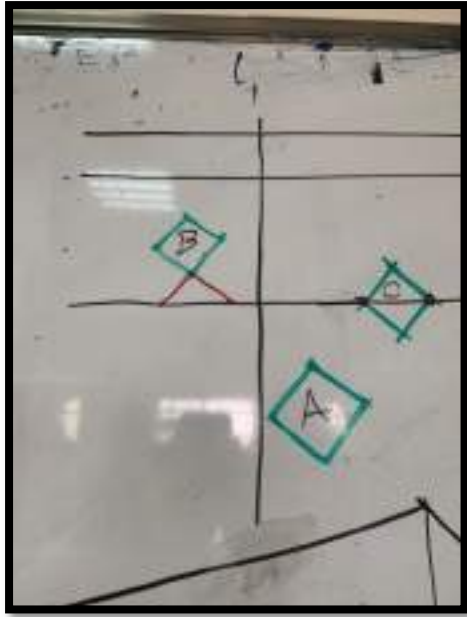

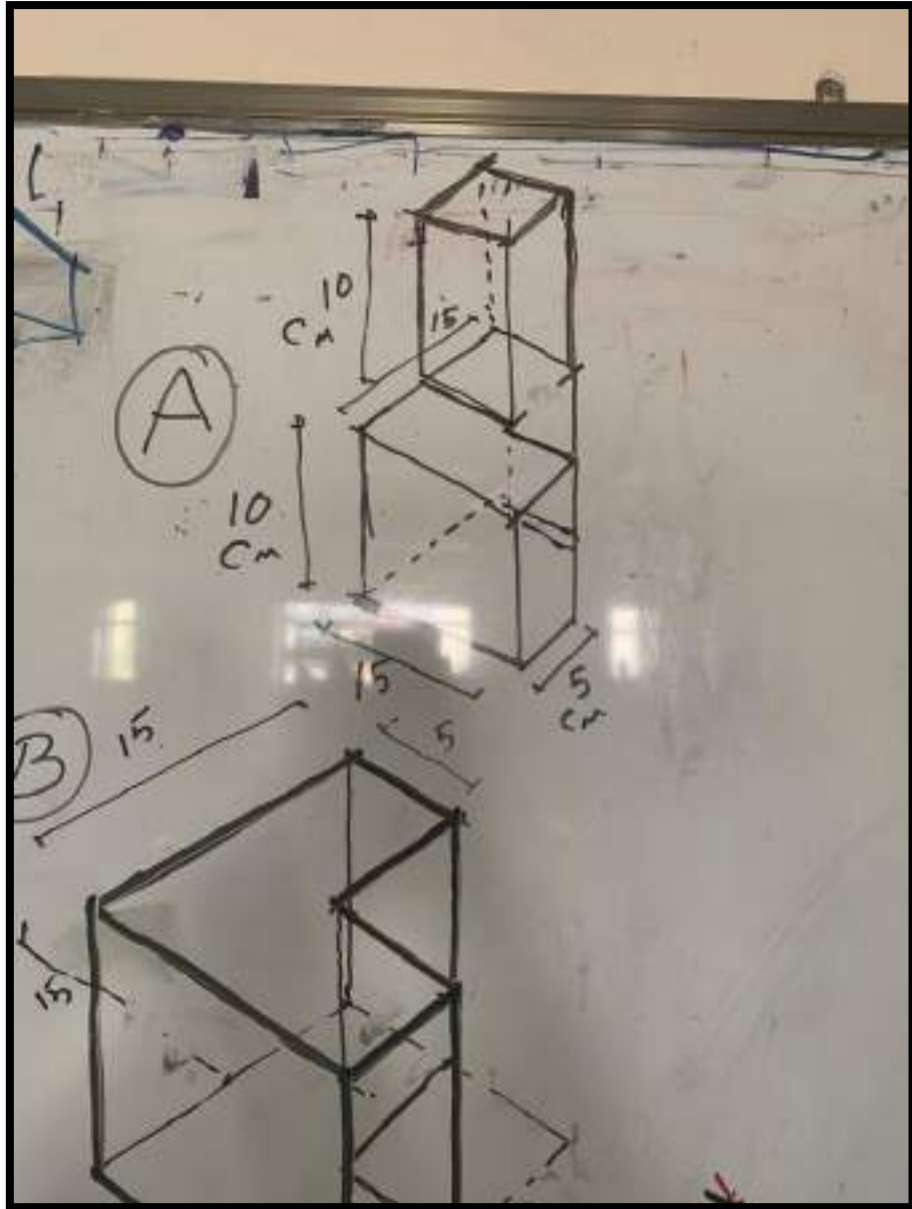

Q15. What is a shade in architecture?

Q16. What is shadow in architecture?

Q17. Why is shadow important in architecture?

Q18. What are casting shadows?

Q19. What is core shadows?

Q20. Why is it important to cast shadows?

Q21. What is needed to cast a shadow?

Q22. What are the 3 conditions for formation of shadow?

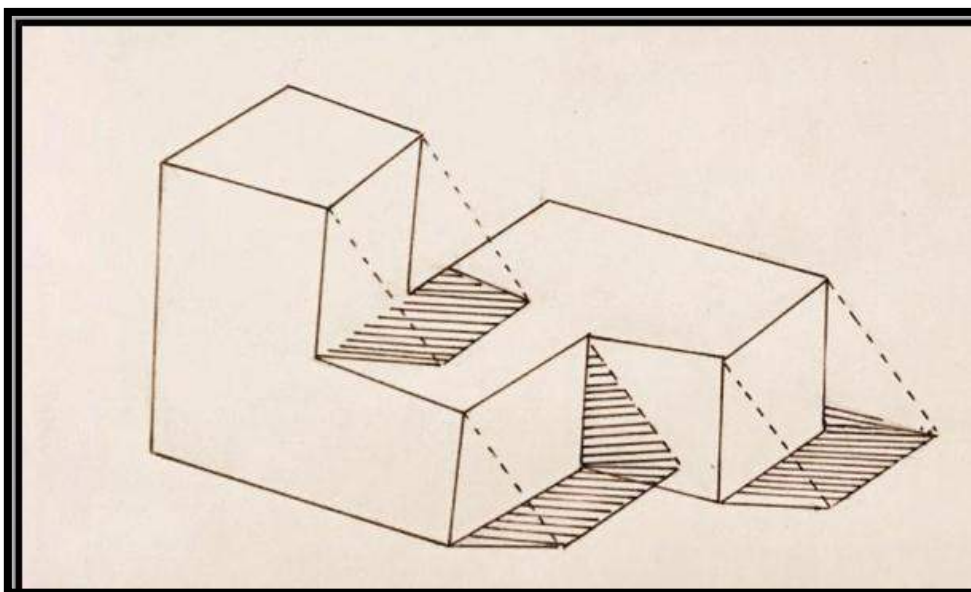
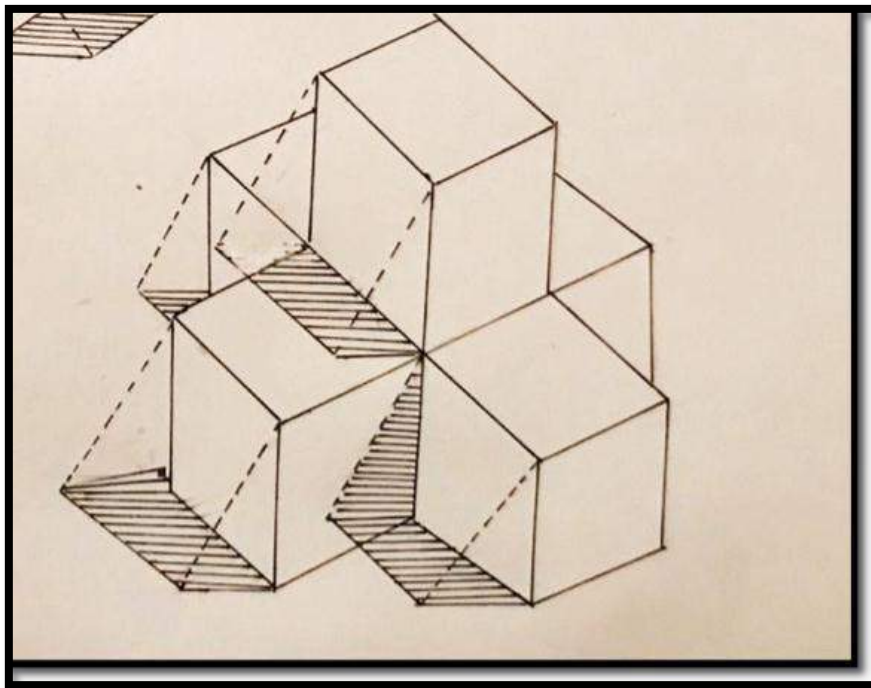

Q23. How do you make a shadow cast?

Q24. How do you add shadows to perspective drawings?

Q25. How do you draw a shadow effect?

Q26. Do shadows follow perspective?

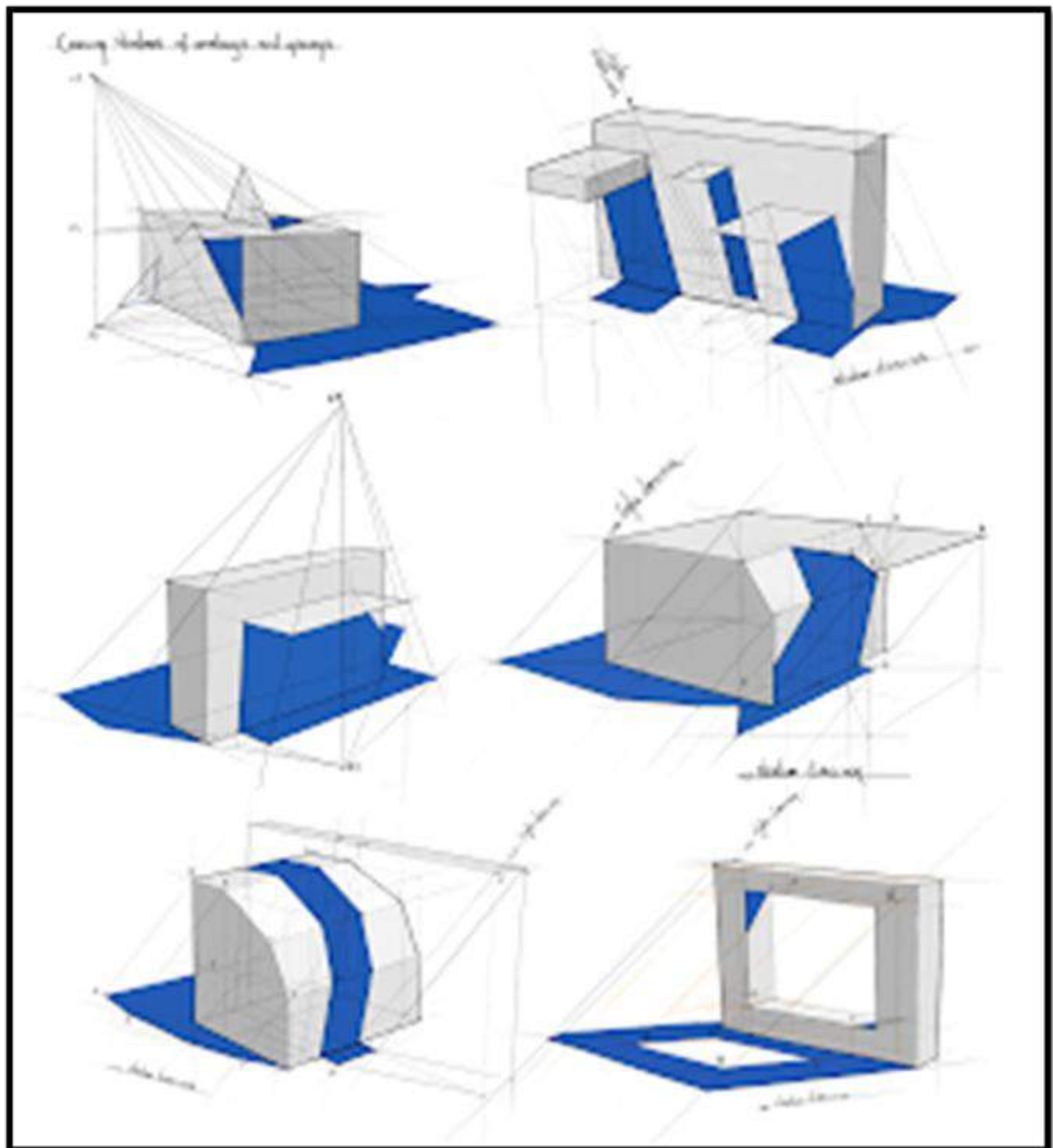

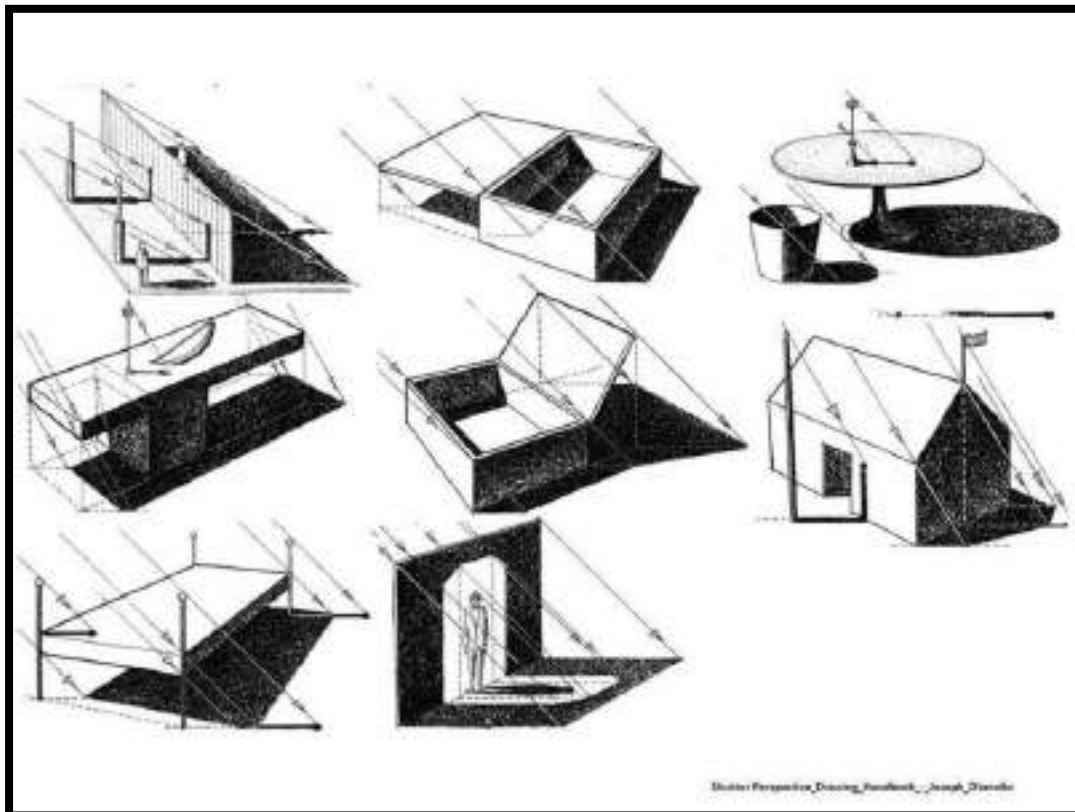
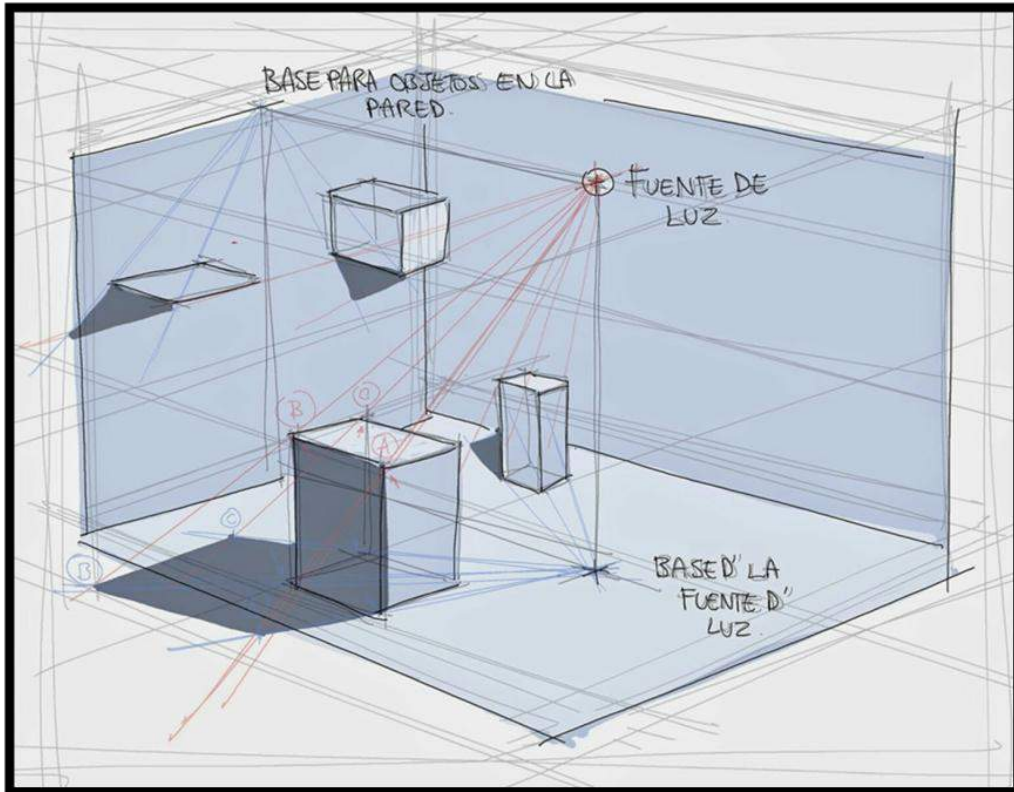

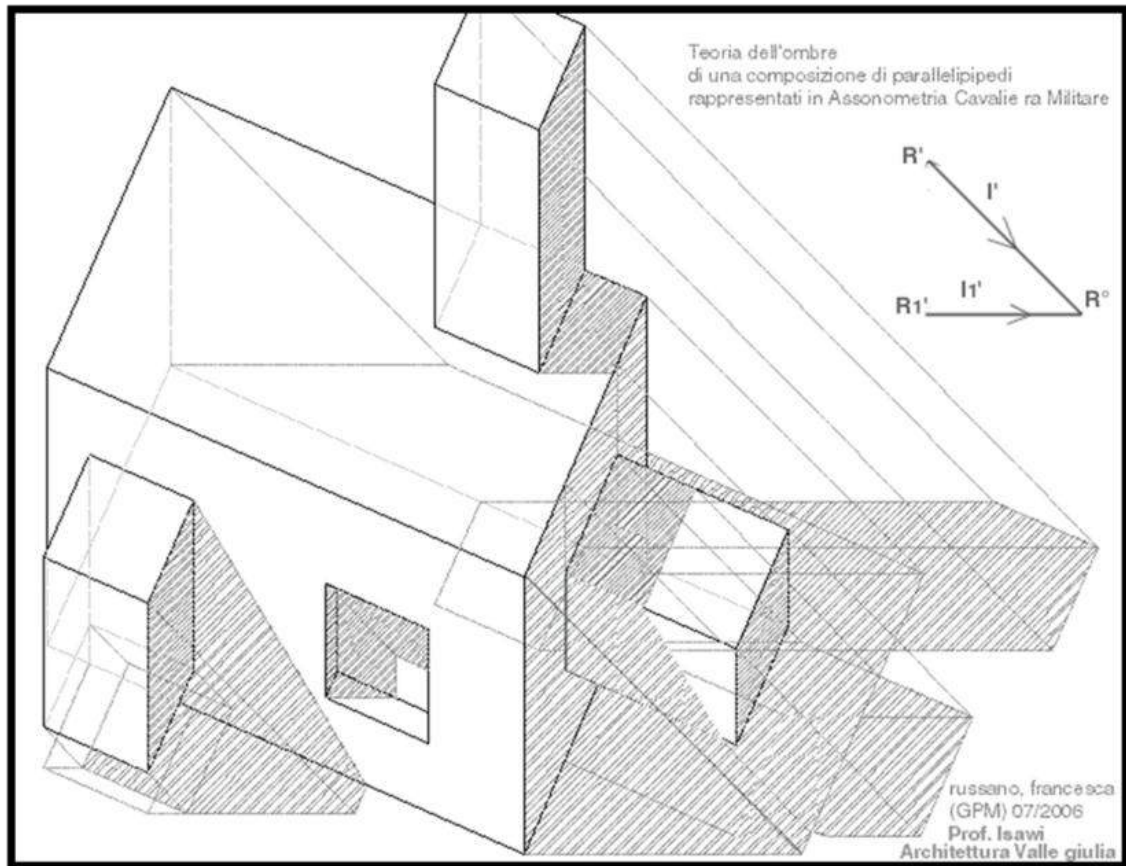

Q27. How to draw stairs side view

Q28. How do you draw a one point perspective bookshelf?

Q29. How do you make a perspective table?

Q30. How do you draw a perspective wall?

Q31. How do you find the point perspective of a station?

Q32. What is station point also known as?

Q33. How do you find perspective projection?

Q34. What are types of perspective projection?

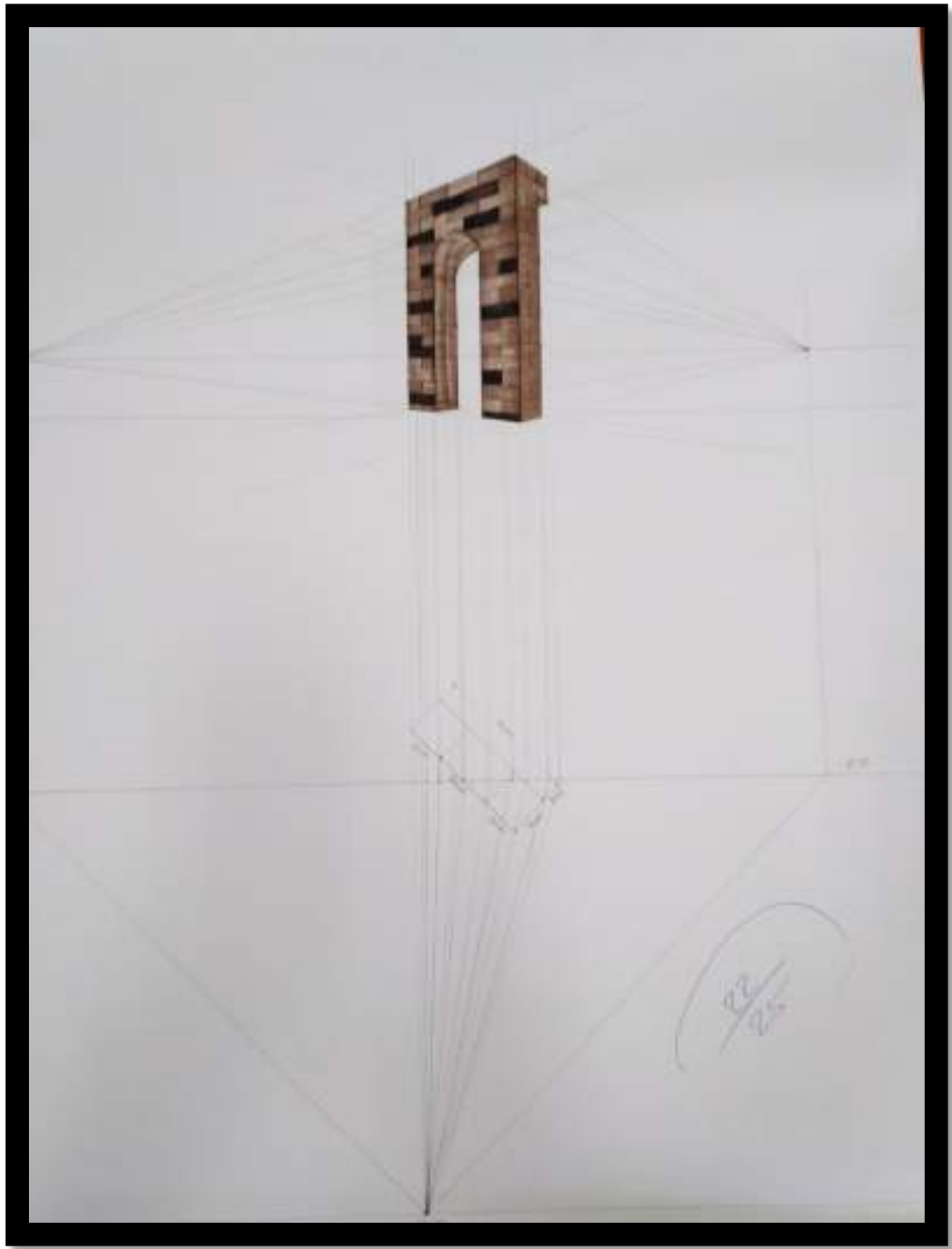

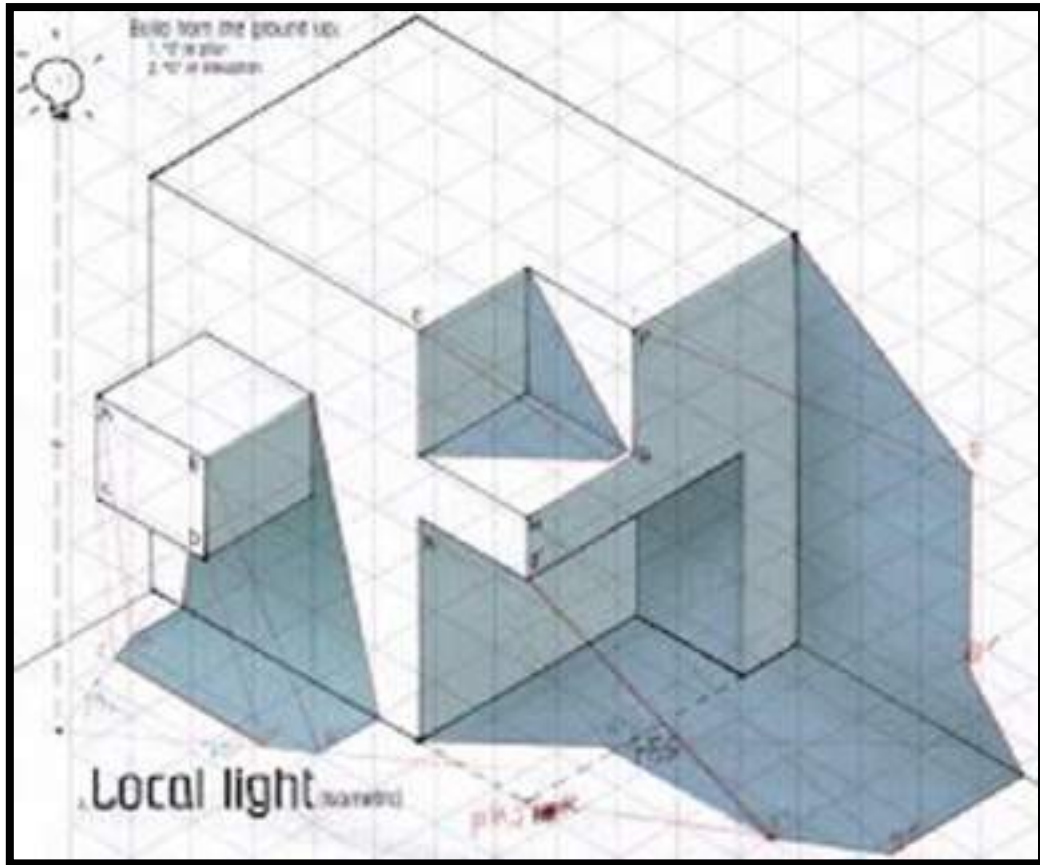

Q35. What is the difference between isometric and perspective?

Q36. Why is an isometric view used?

Q37. How do you use isometric perspective?

Q38. Who uses perspective?

Q39. What is an example of a linear perspective?

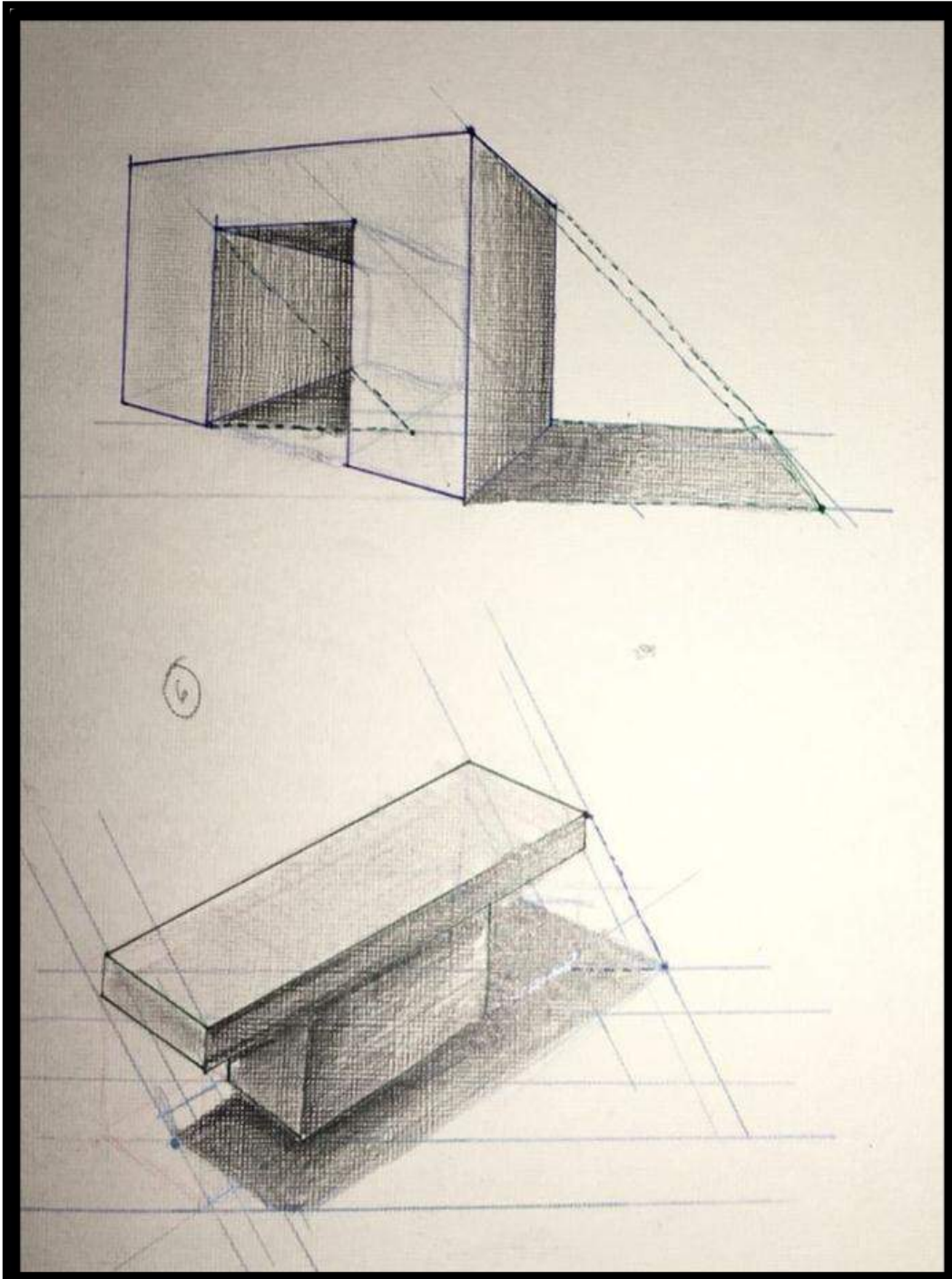

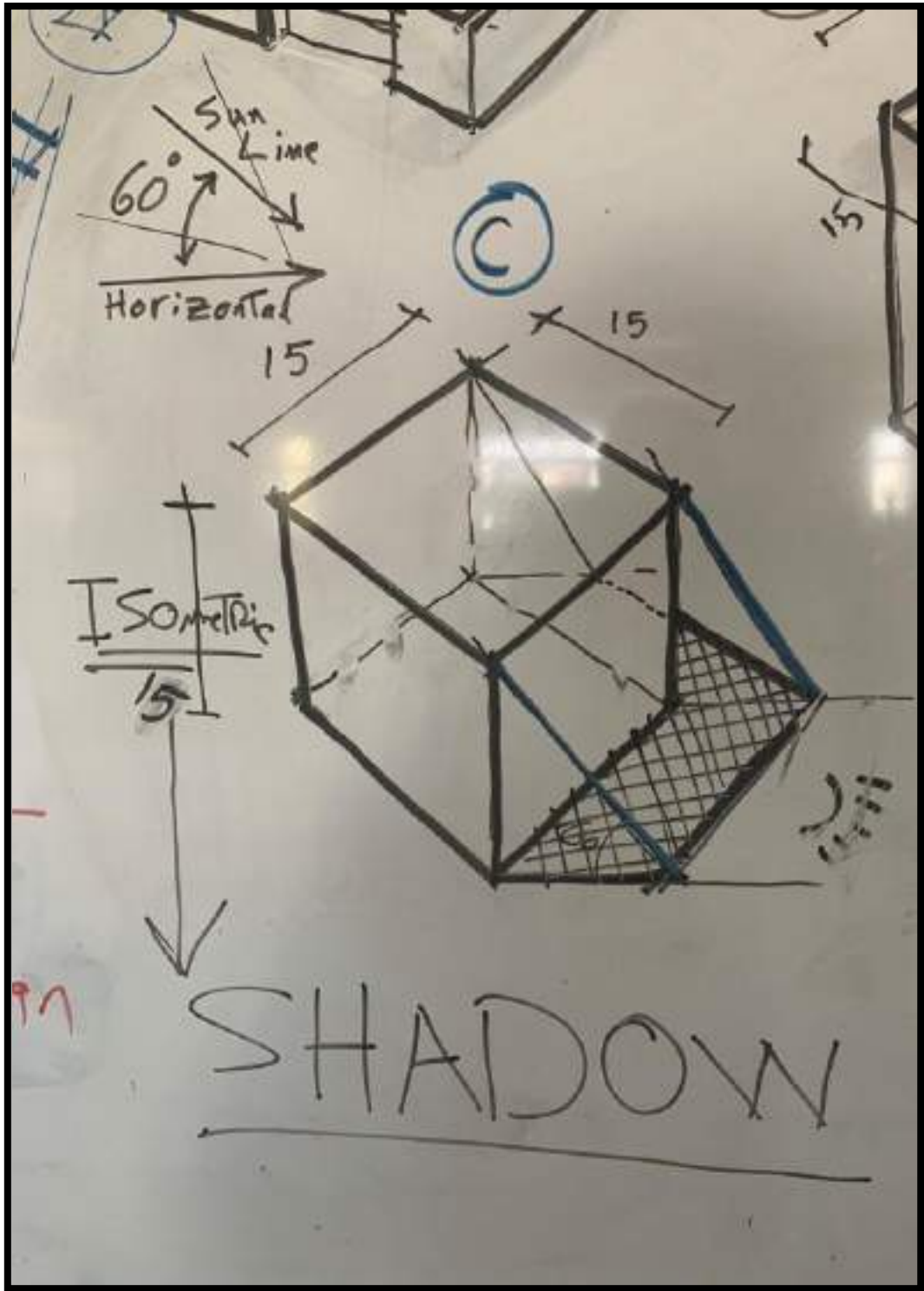

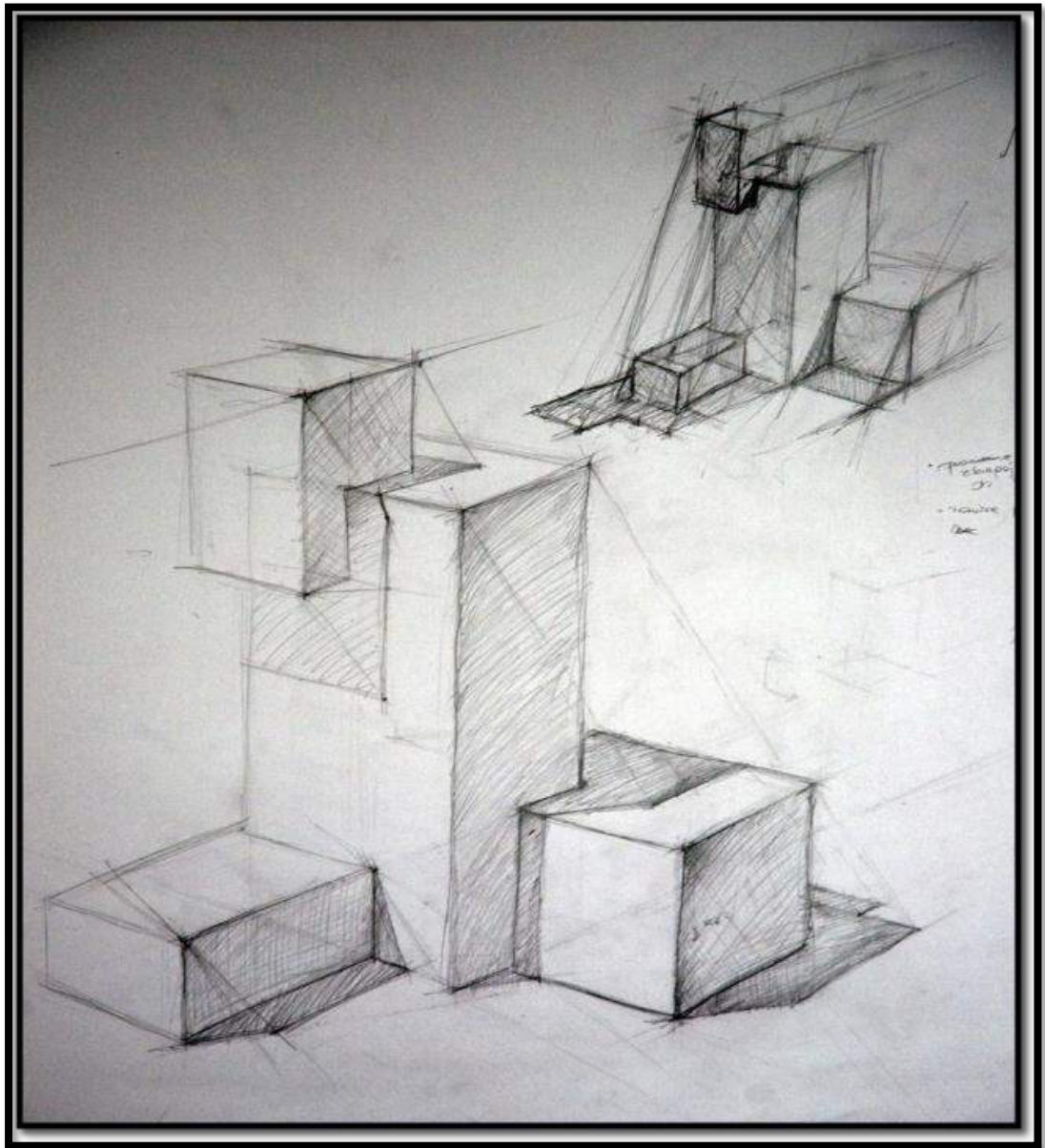

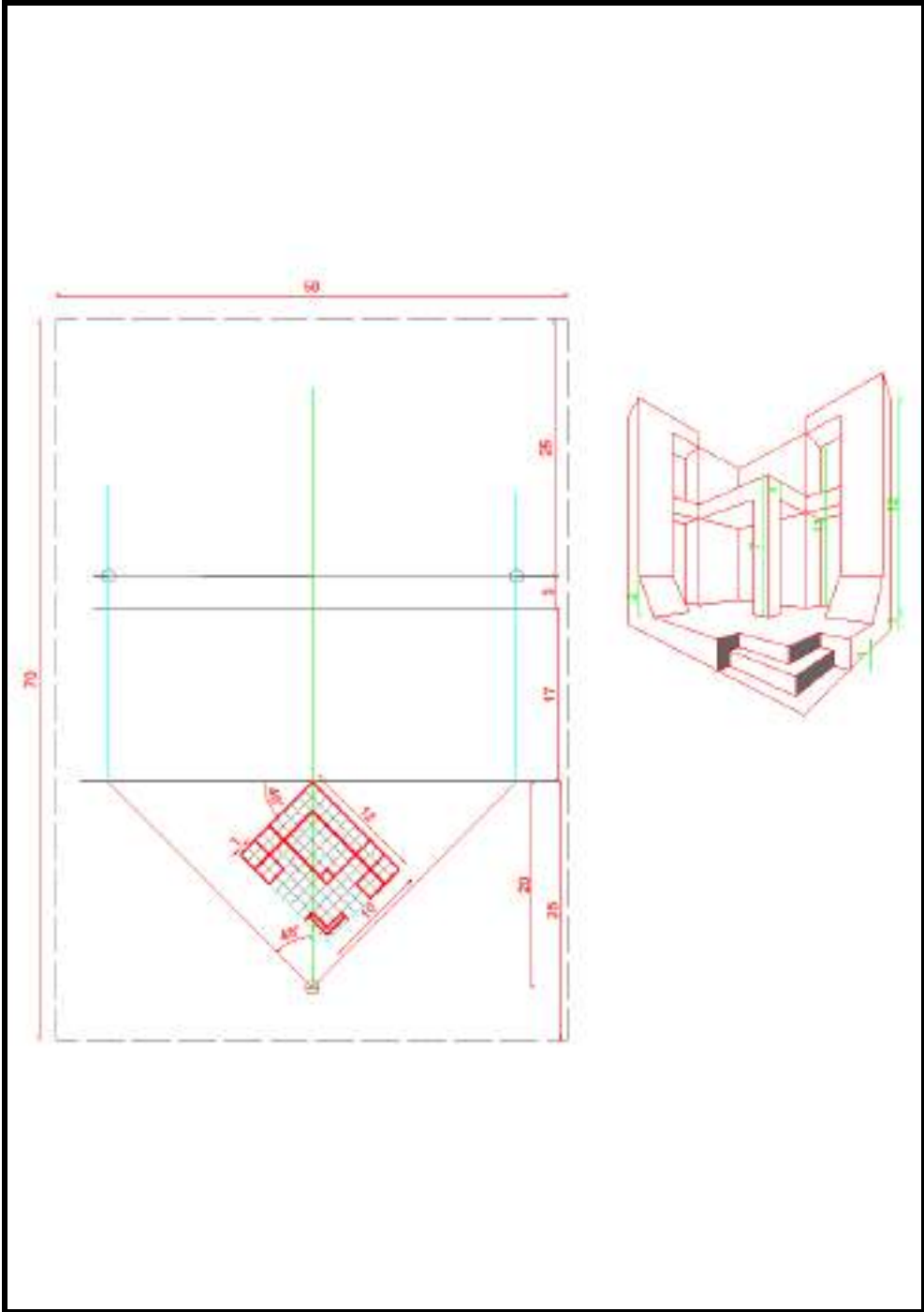

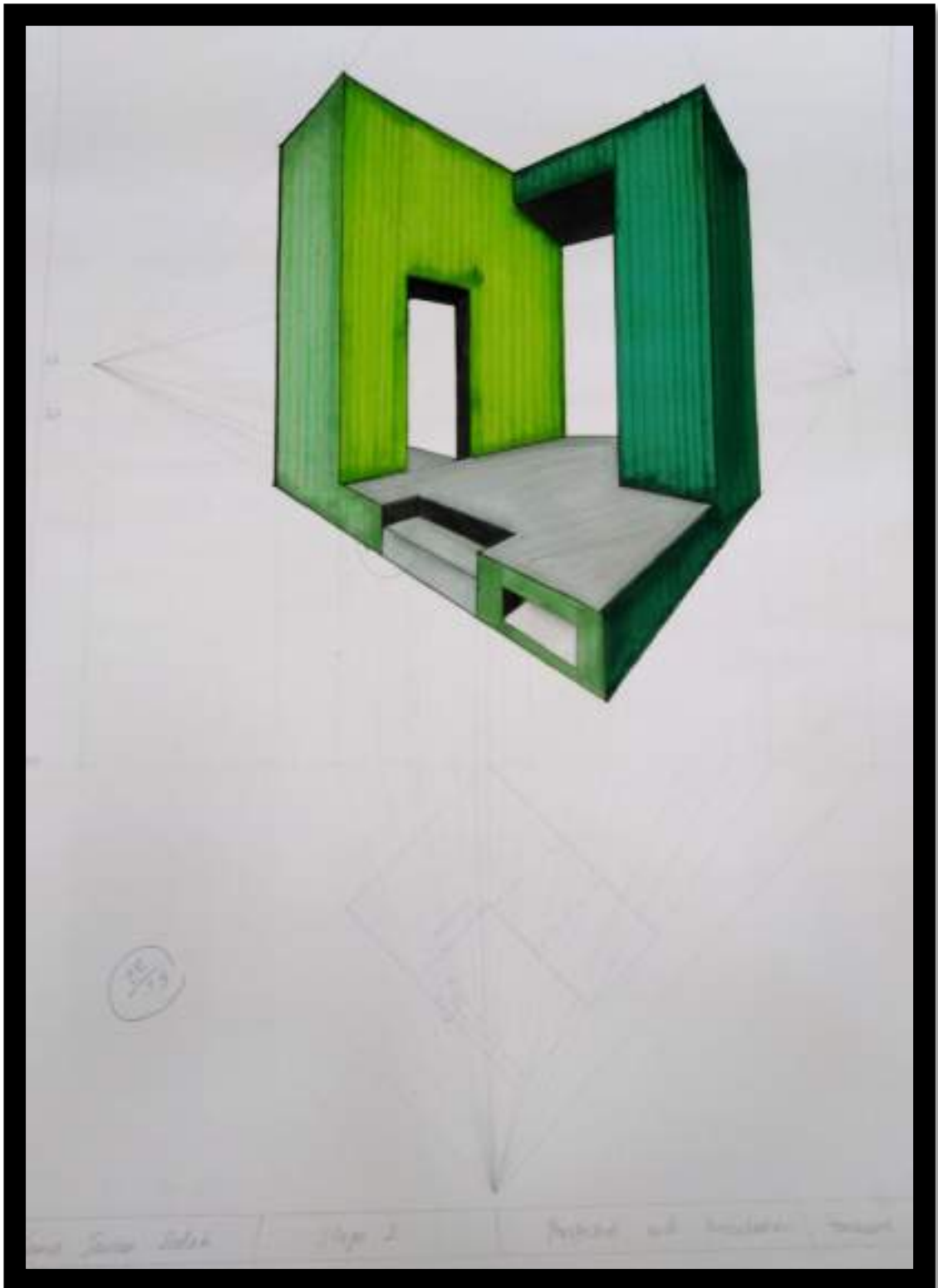

and Simon Loh

Step 2

Project and Architecture

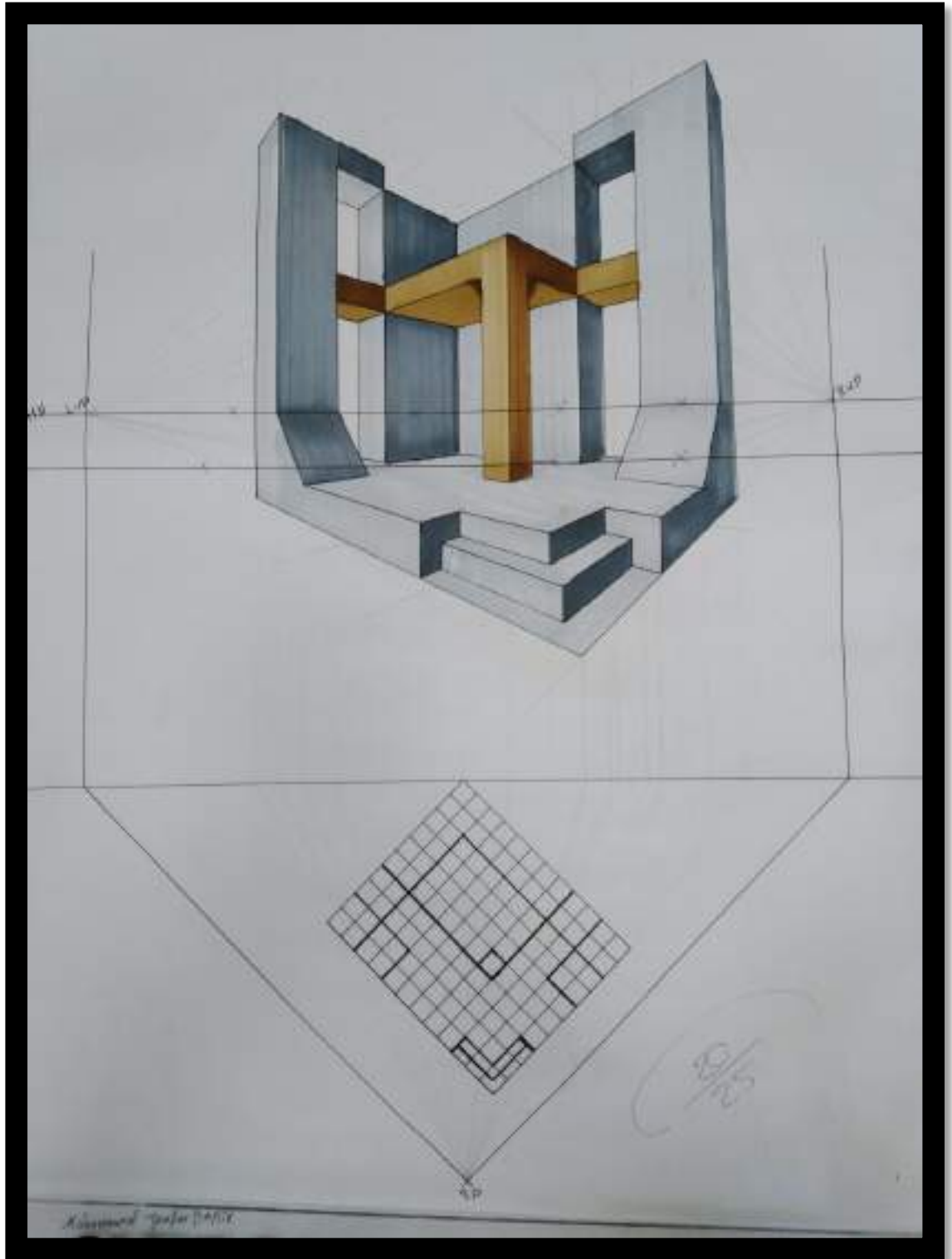



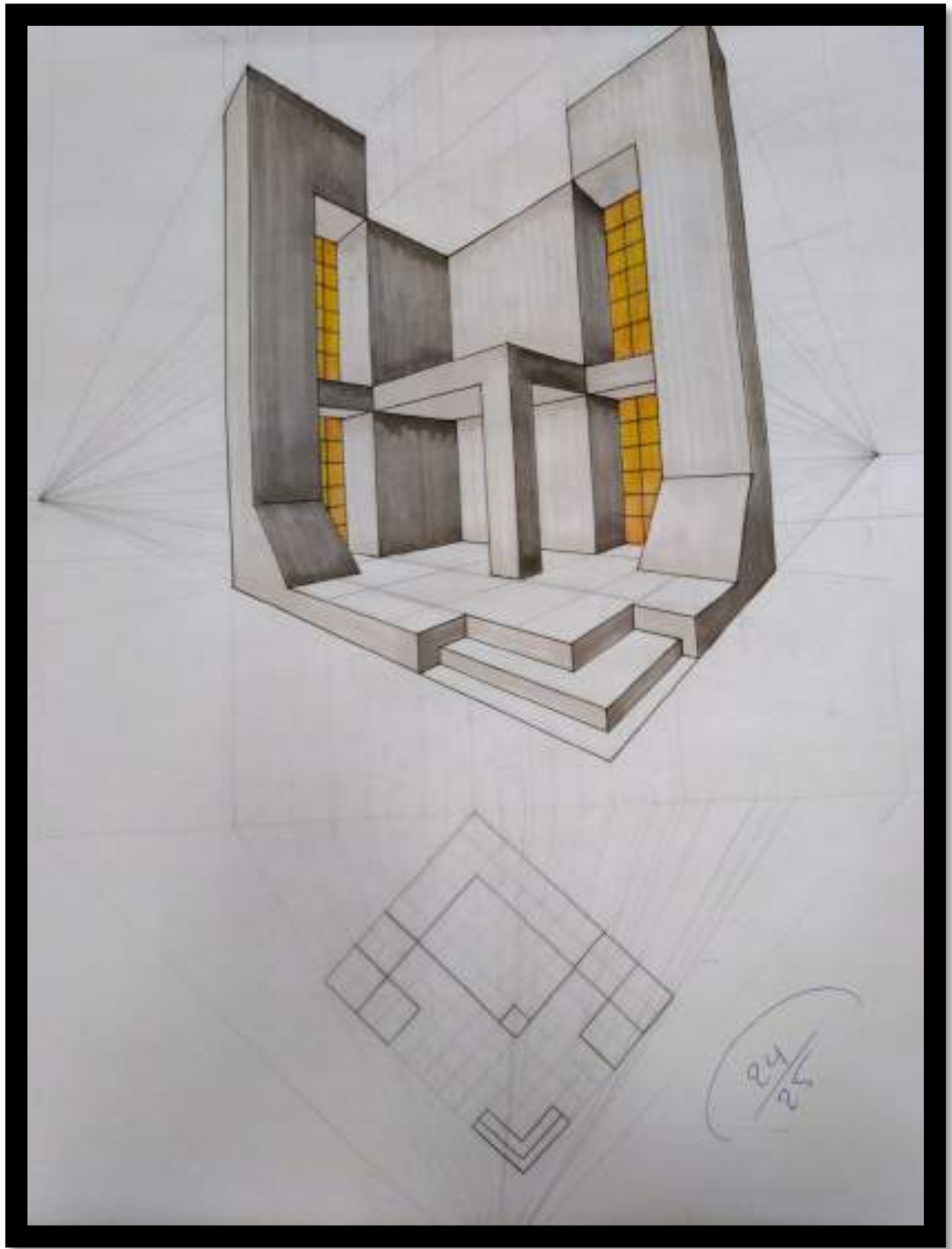

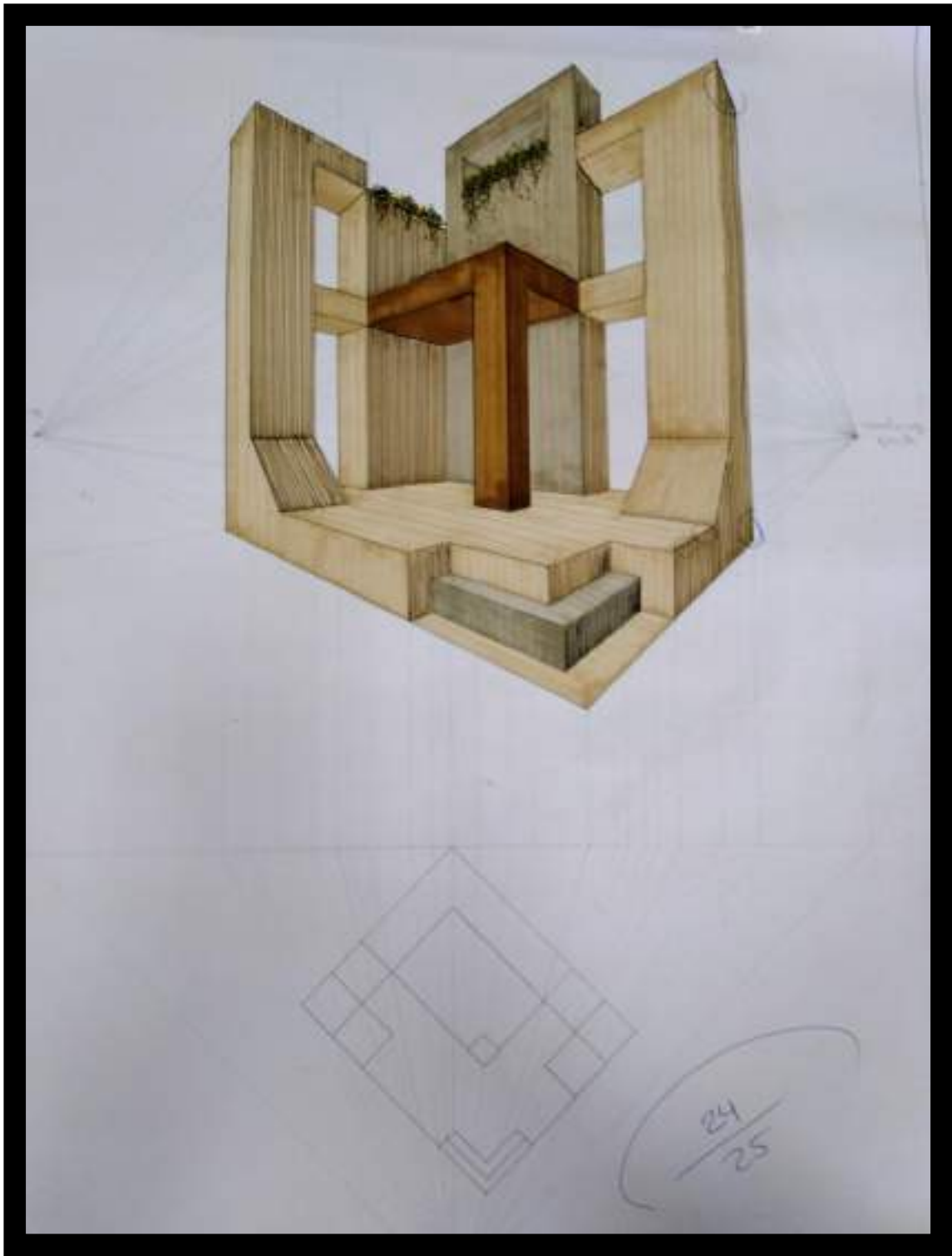

Q. DRAW A PERSPECTIVE FOR THE FORM BELOW THROUGH A PERSPECTION.

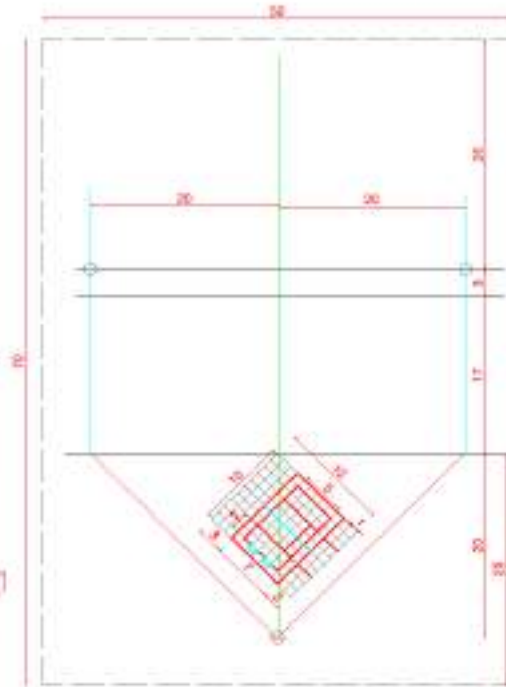





01
/ 05

Hossen Abdollahi

Second Stage

Monday - 2/11/2021





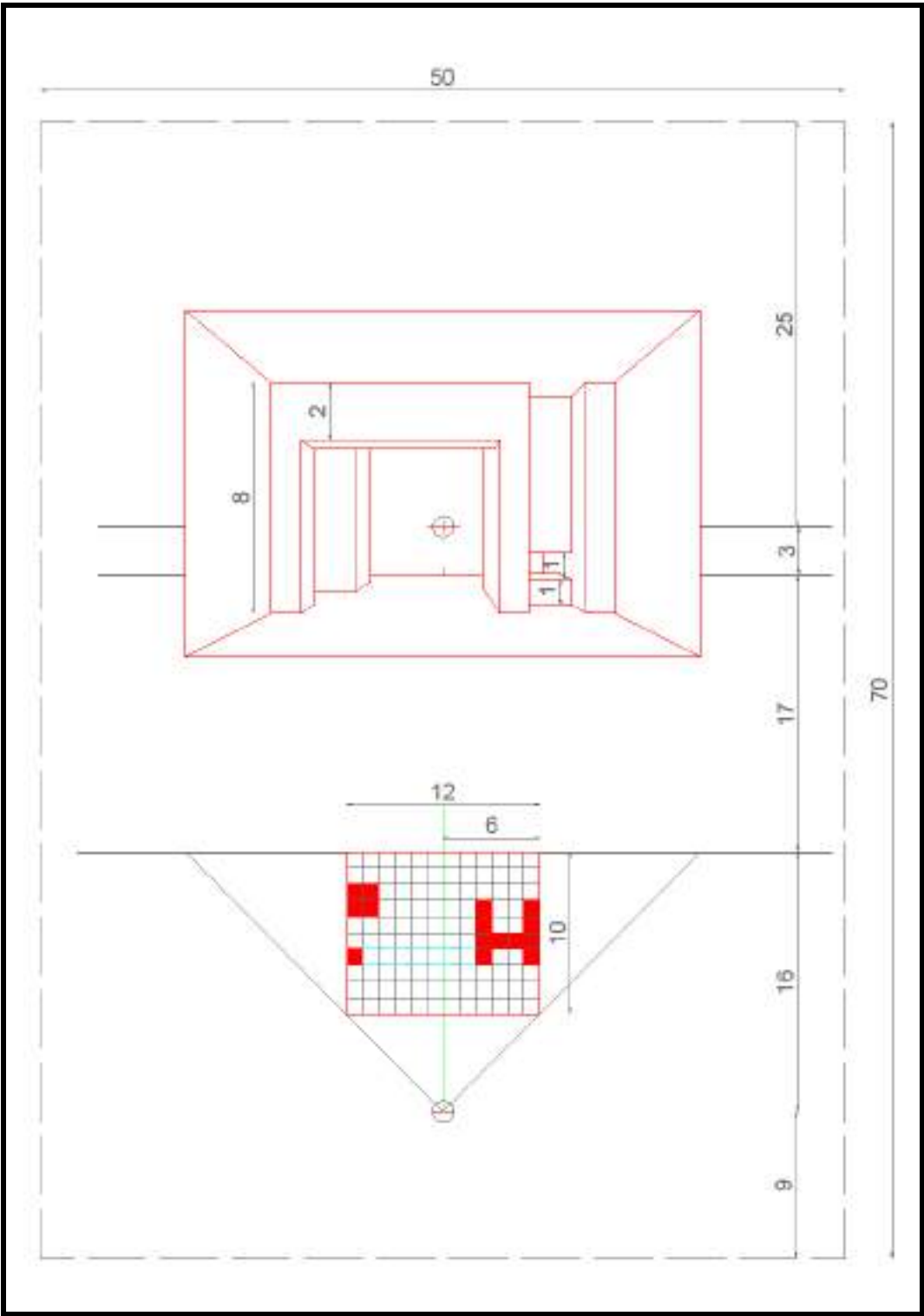

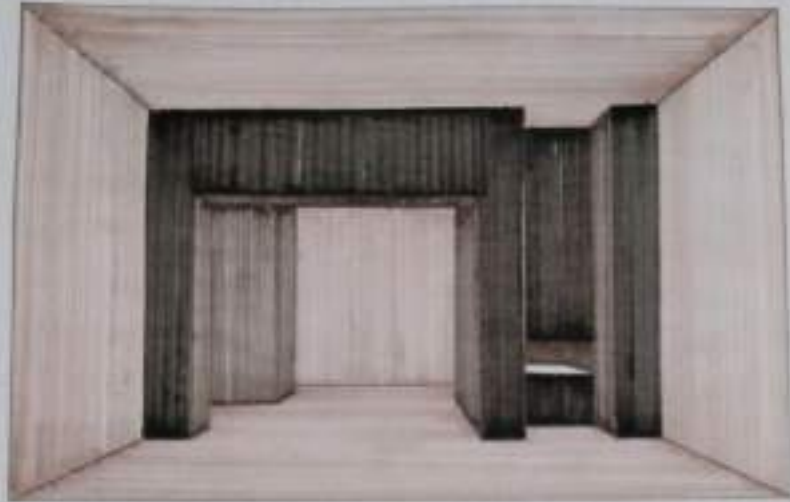

16
25

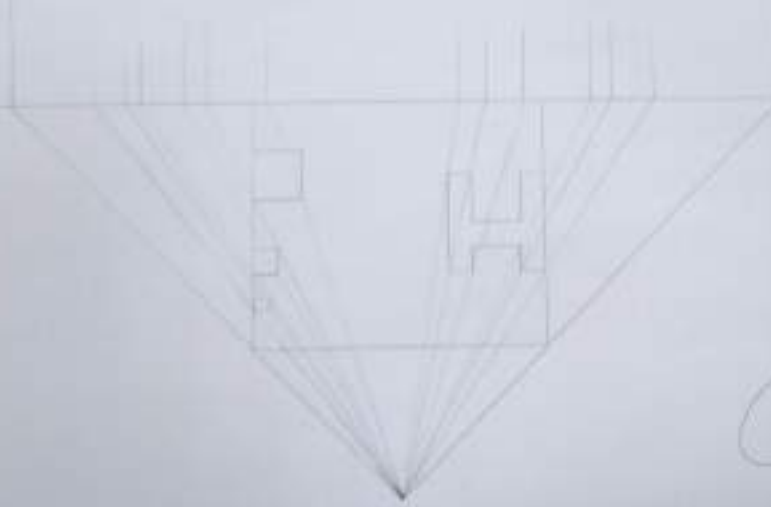

Artistic drawing
195

17
25

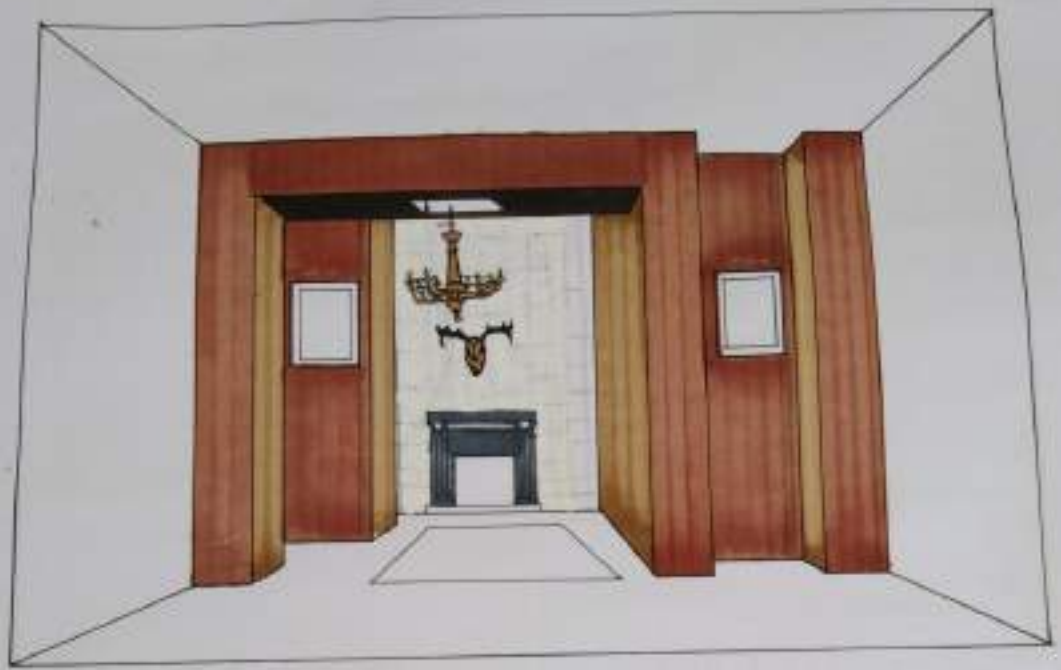

10

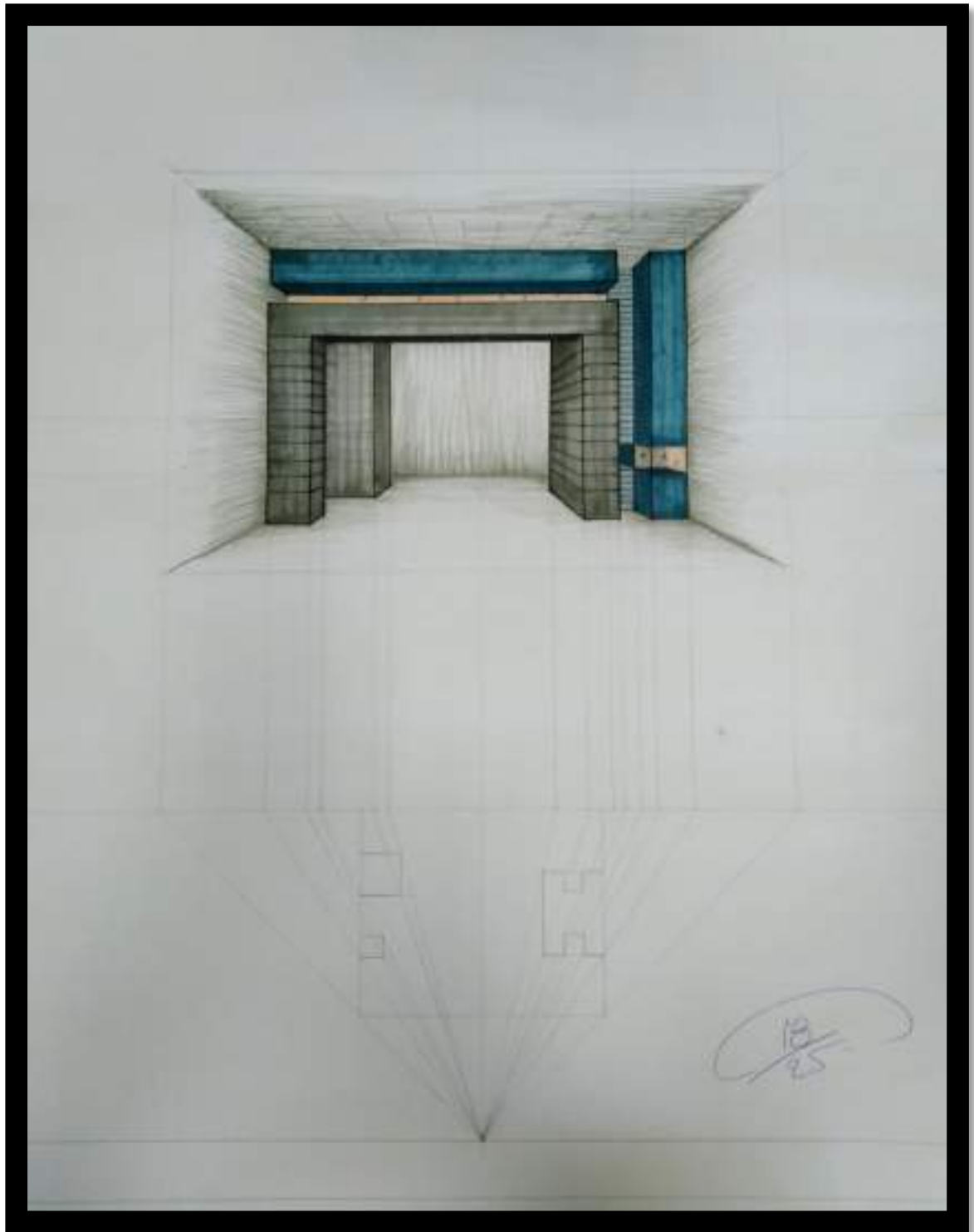

Q40. What is a one-point perspective room?

Q41. How do you draw a room in one-point perspective?

Q42. What are the steps to draw one point perspective?

Q43. What perspective do you use when drawing a room?

Q44. Why is it called one-point perspective?

Q45. Do we see in 1 point perspective?

Q46. Who invented 1 point perspective?

Q47. Who uses one-point perspective?

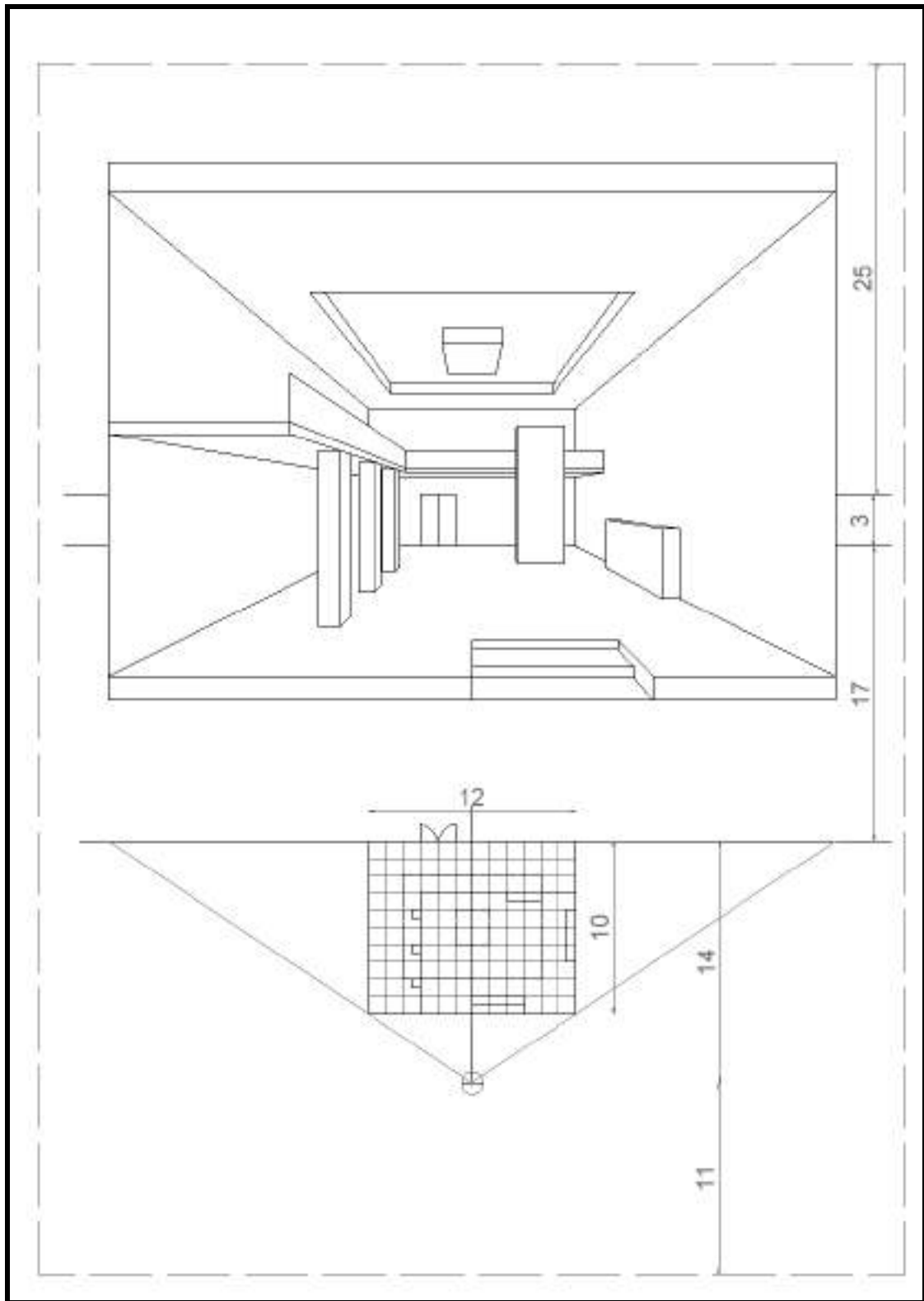



HL

GL

FP

22/25

SP

Narisa Salem Atham

HW

Pastelche

2nd stage



3.0
0.0

0.0

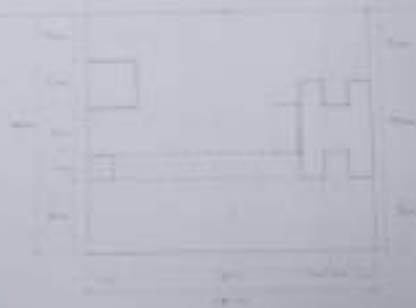

23
05

Ayda Fauzan Abdullah

Second Stage

10/11/2023

- Q48. How do you draw depth in a room?
- Q49. What are the 3 main views of isometric?
- Q50. Is isometric a two point perspective?
- Q51. Who uses isometric perspective?
- Q52. What angle is isometric view?
- Q53. Is isometric always 30 degrees?
- Q54. Is isometric 60 degrees?
- Q55. How many faces are isometric?
- Q56. How do you shadow isometric?
- Q57. What is perspective shadow?
- Q58. What technique is shadow?
- Q59. What are the 3 types of shadowing?

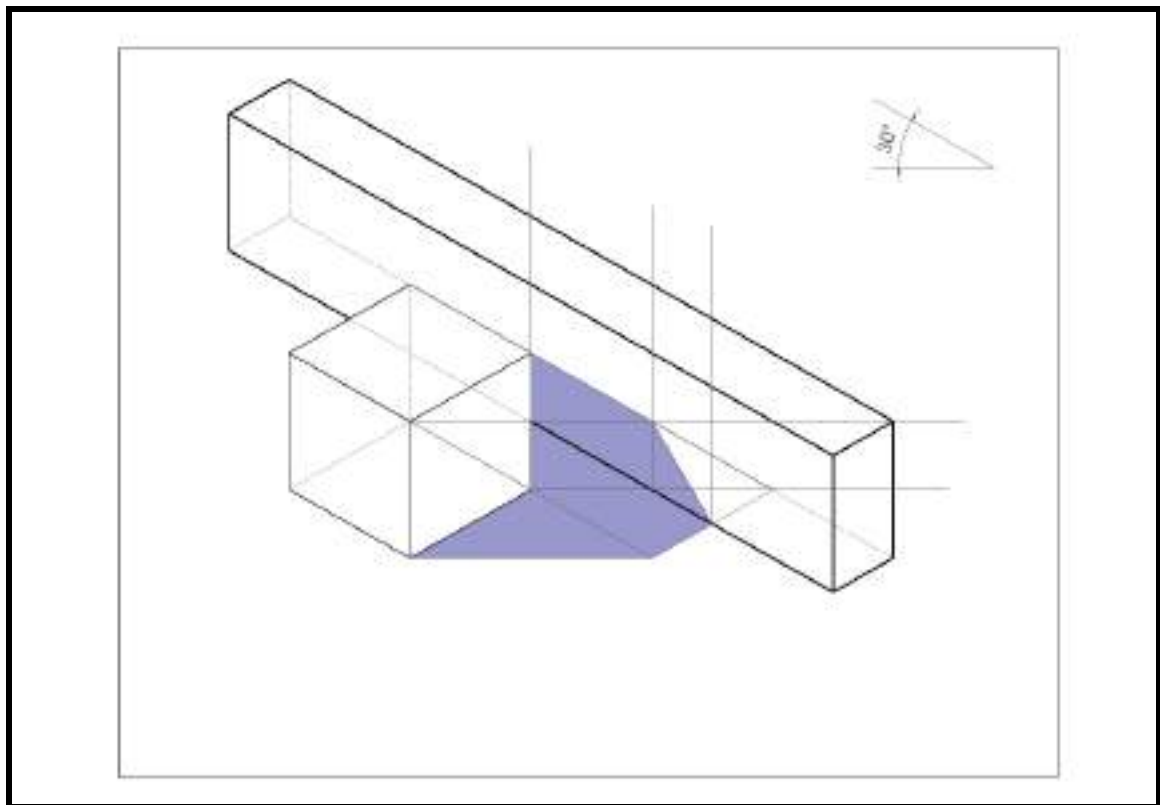

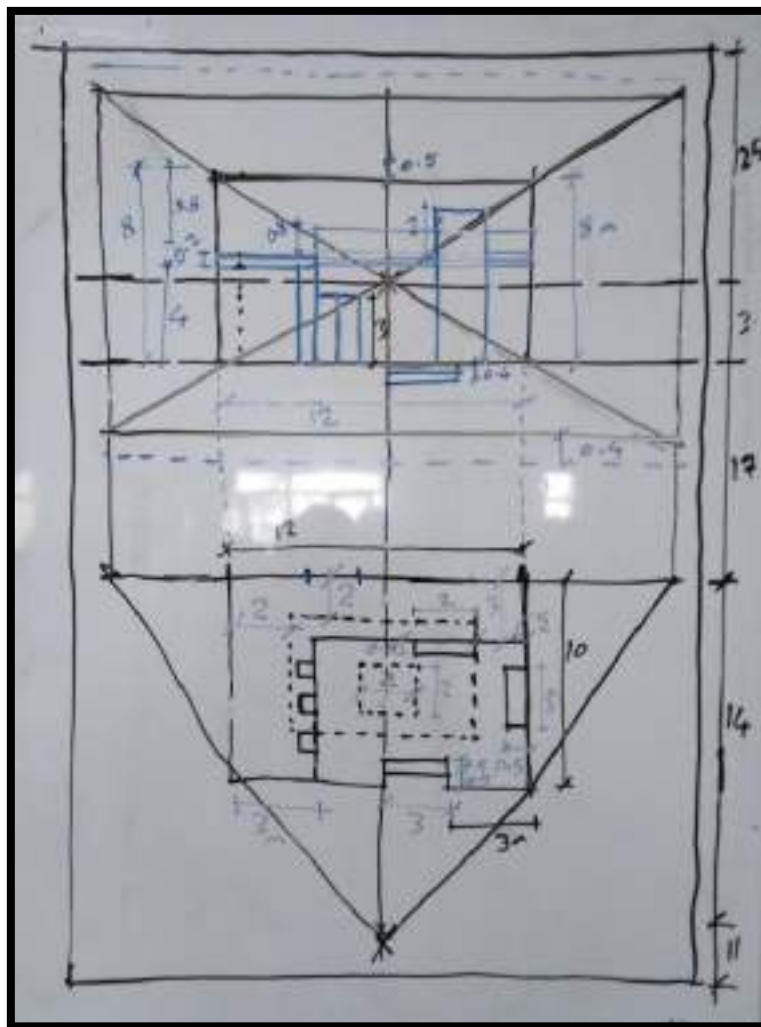
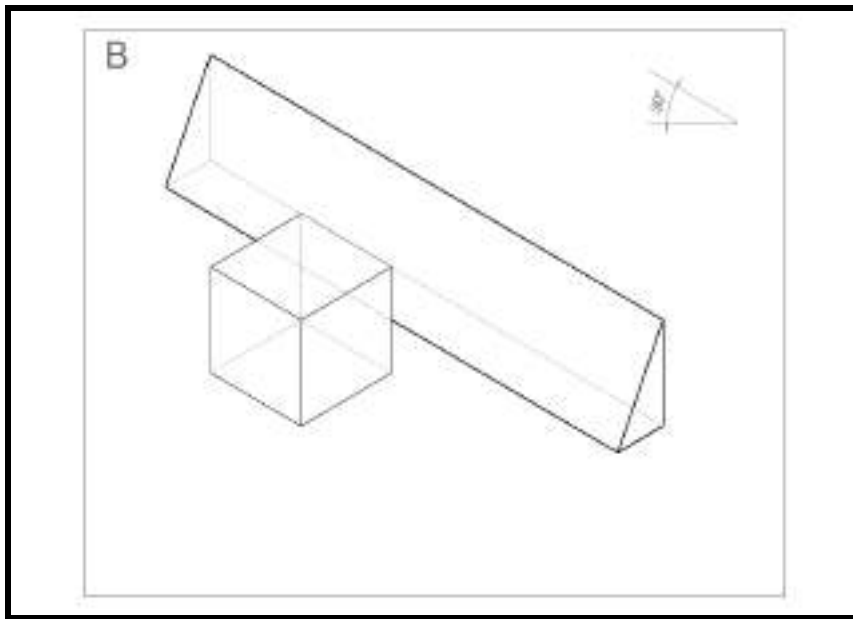

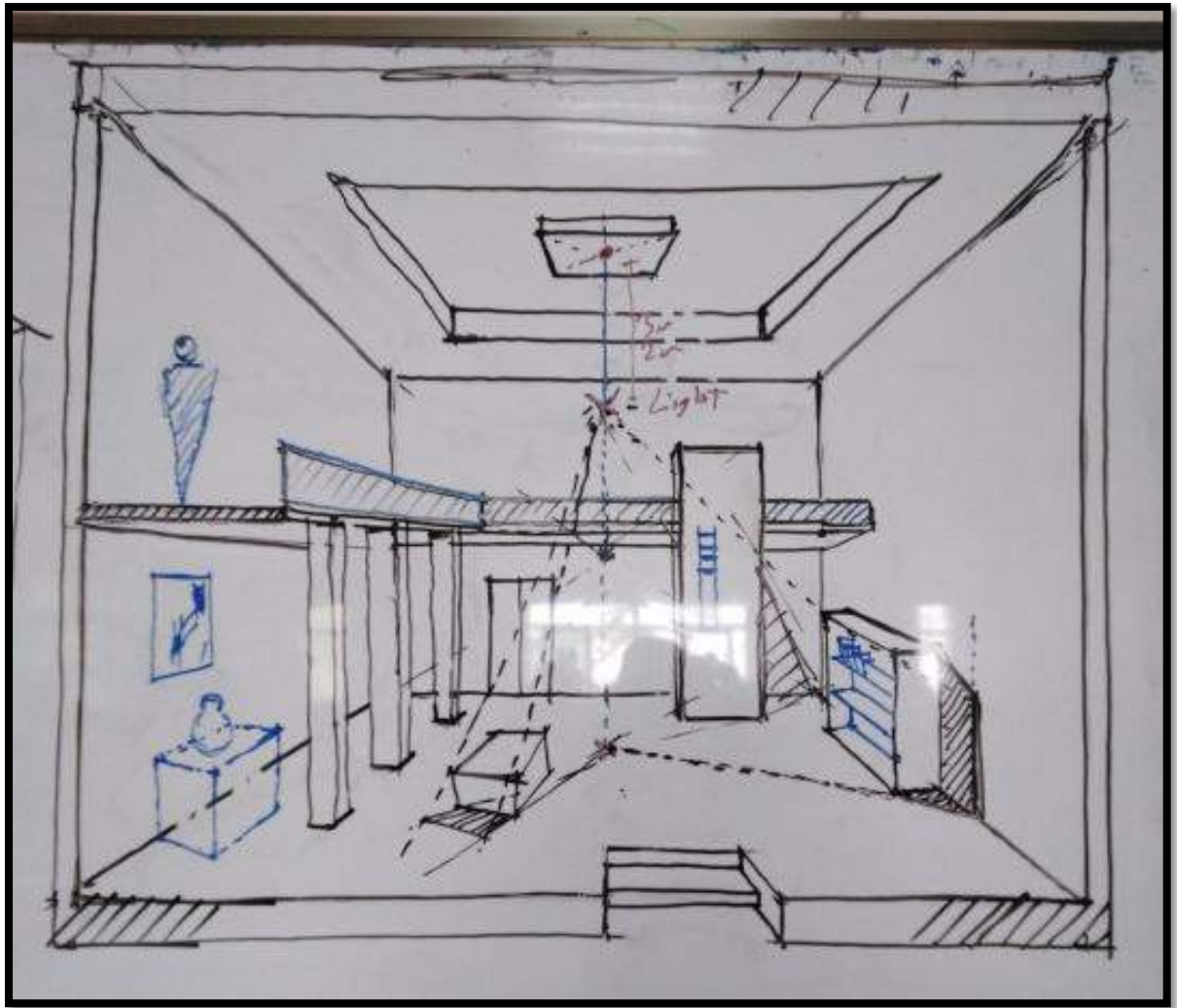

Q60. What is a staircase that goes two ways?

Q61. What are the 4 types of perspective?

Q62. What is 4 point perspective?

Q63. How do you draw a 5 point perspective room?



18
25

18/25

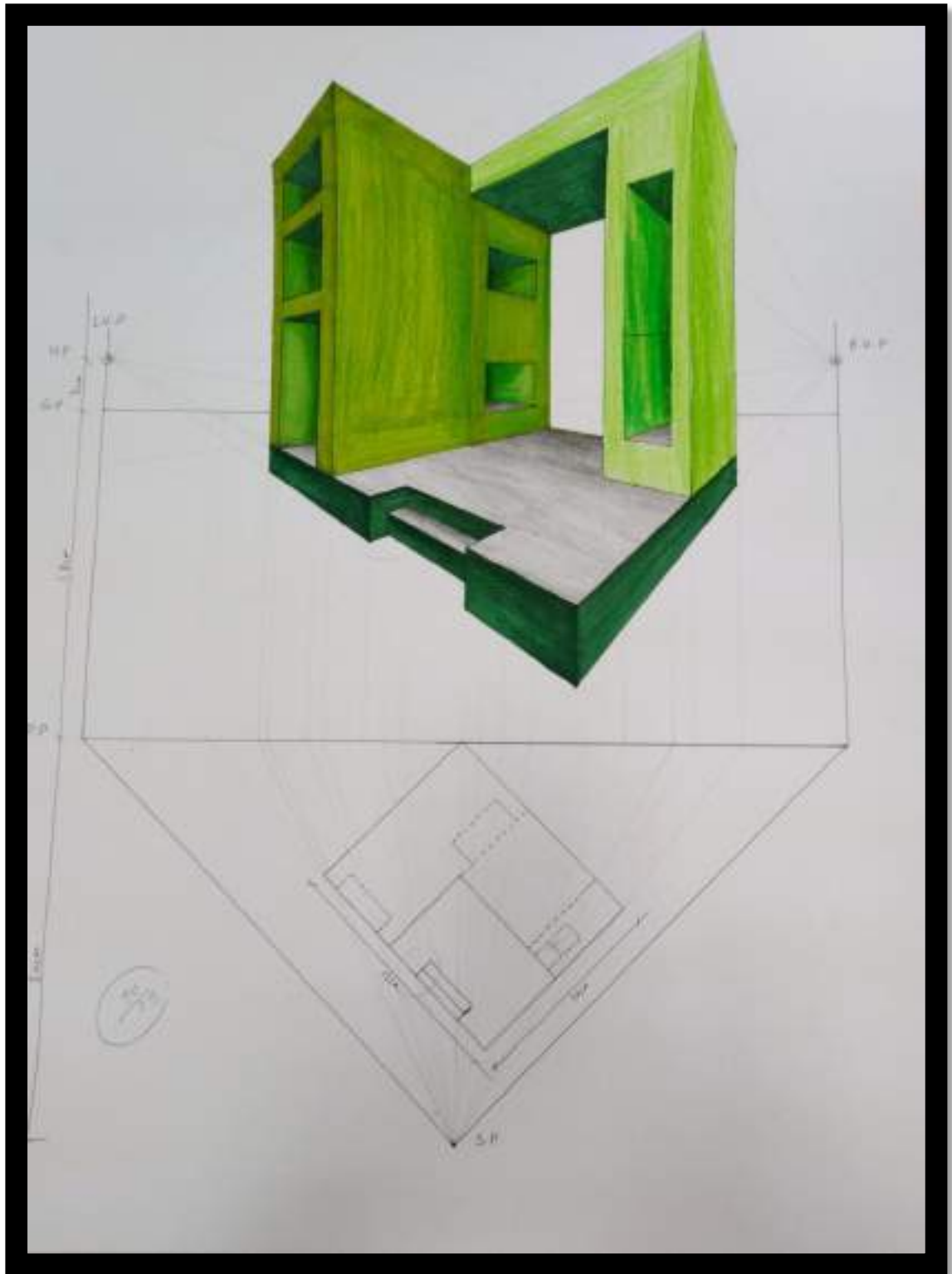

Q64.How can I design my drawing room?

Q65.Why do designers use 2 point perspective?

Q66.How do you draw a circle in perspective 2 points?

Q67.How do you draw a staircase in two point perspective?



H.W. 4th April
Arjun Borkar

20/05





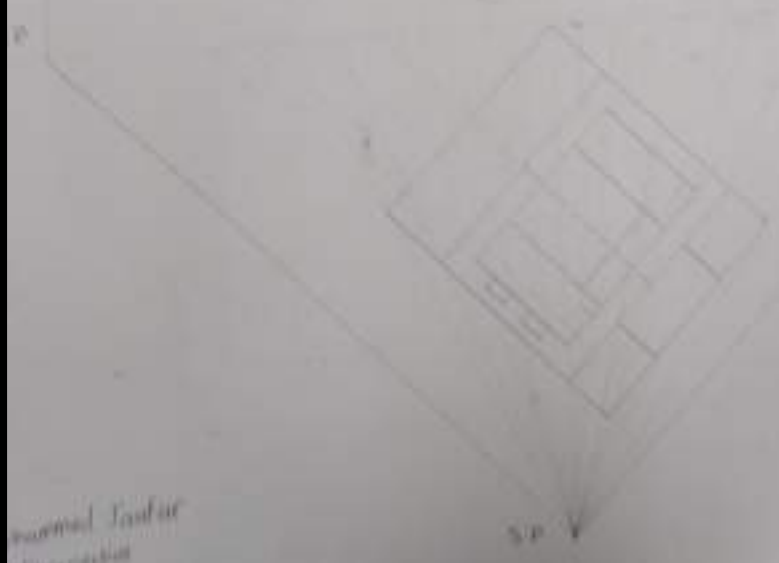

13/15

normal facade
perspective

SP V



UIN Ar-Raniry, Department of Architecture
11/15/2015

Heruandono and Fauziah
Yama Samudra Selay





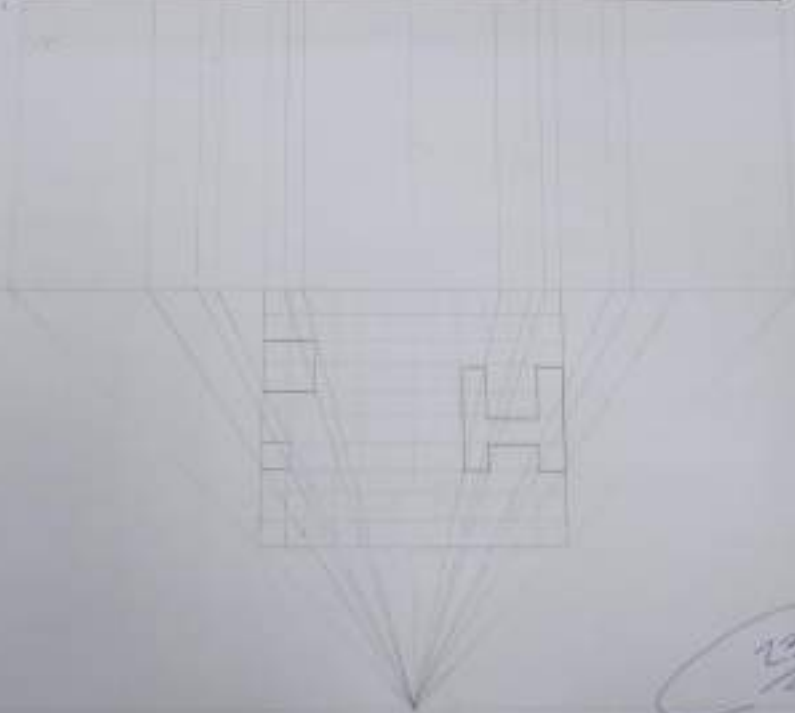

23/25

Q68. How do you draw a table in a room in one point perspective?

Q69. What are the 3 rules of perspective drawing?

Q70. How to draw a 2 d room?

Q71. Where is linear perspective used?

Q72. What is the most used perspective?

Q73. How do you draw a 3 point perspective room?

Q74. How do you draw two point perspective stairs and rooms?

Q75. How to draw a room in 3d?

Q76. What are the 3 types of linear perspective?

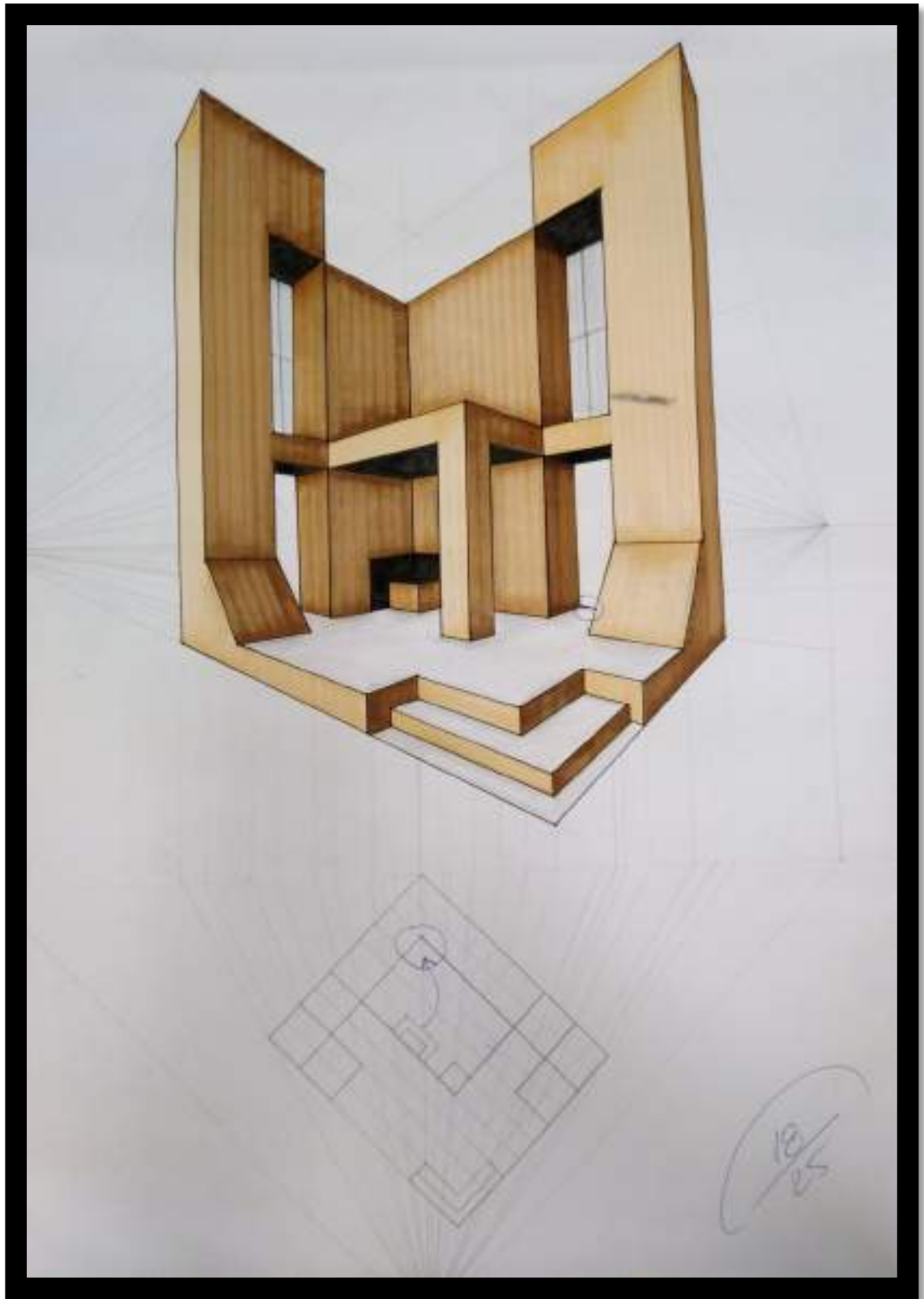



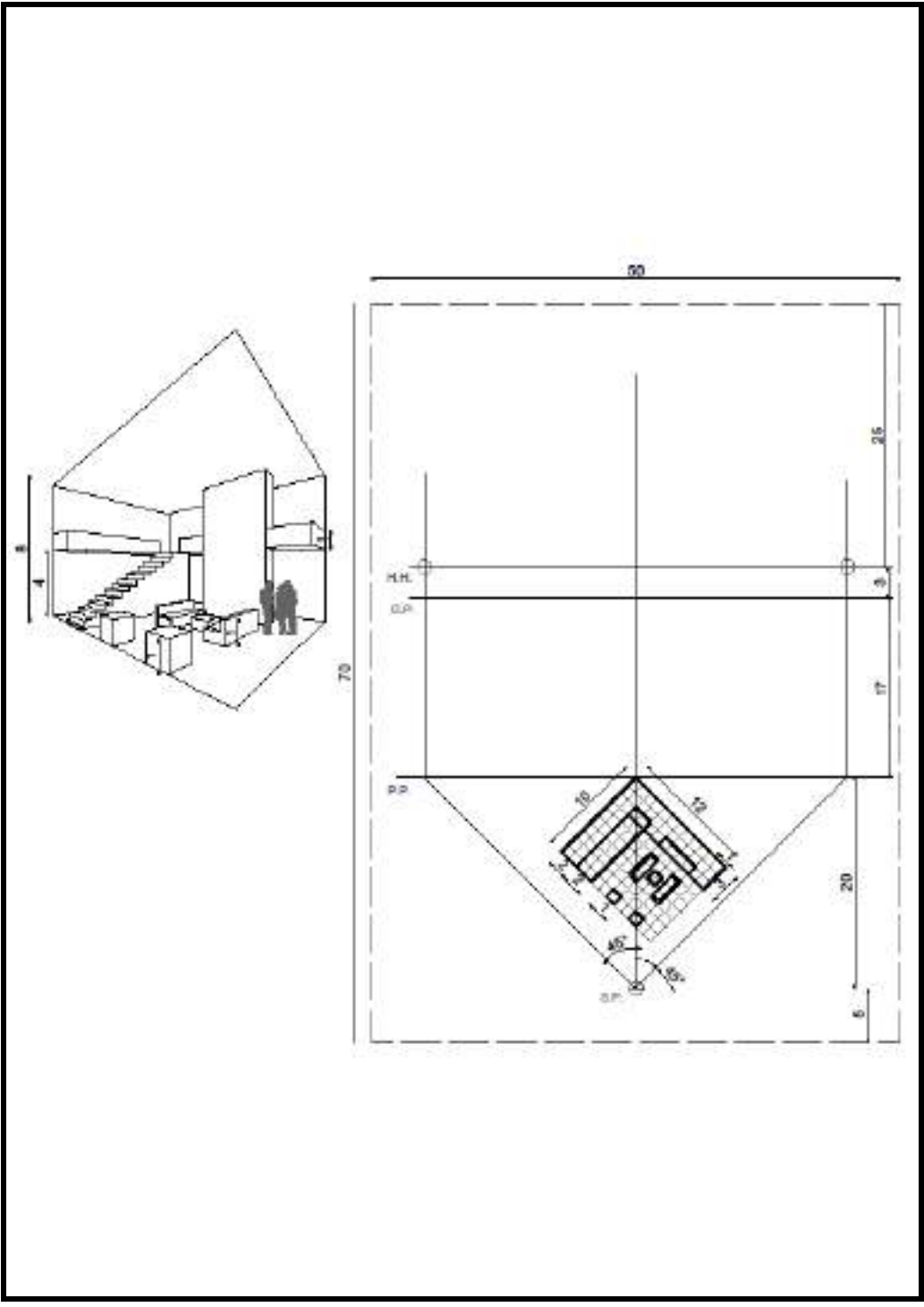

Q77. What are the two types of shadow?

Q78. What are the properties of shadows?

Q79. What are the positions of shadows?

Q80. What is a form shadow?

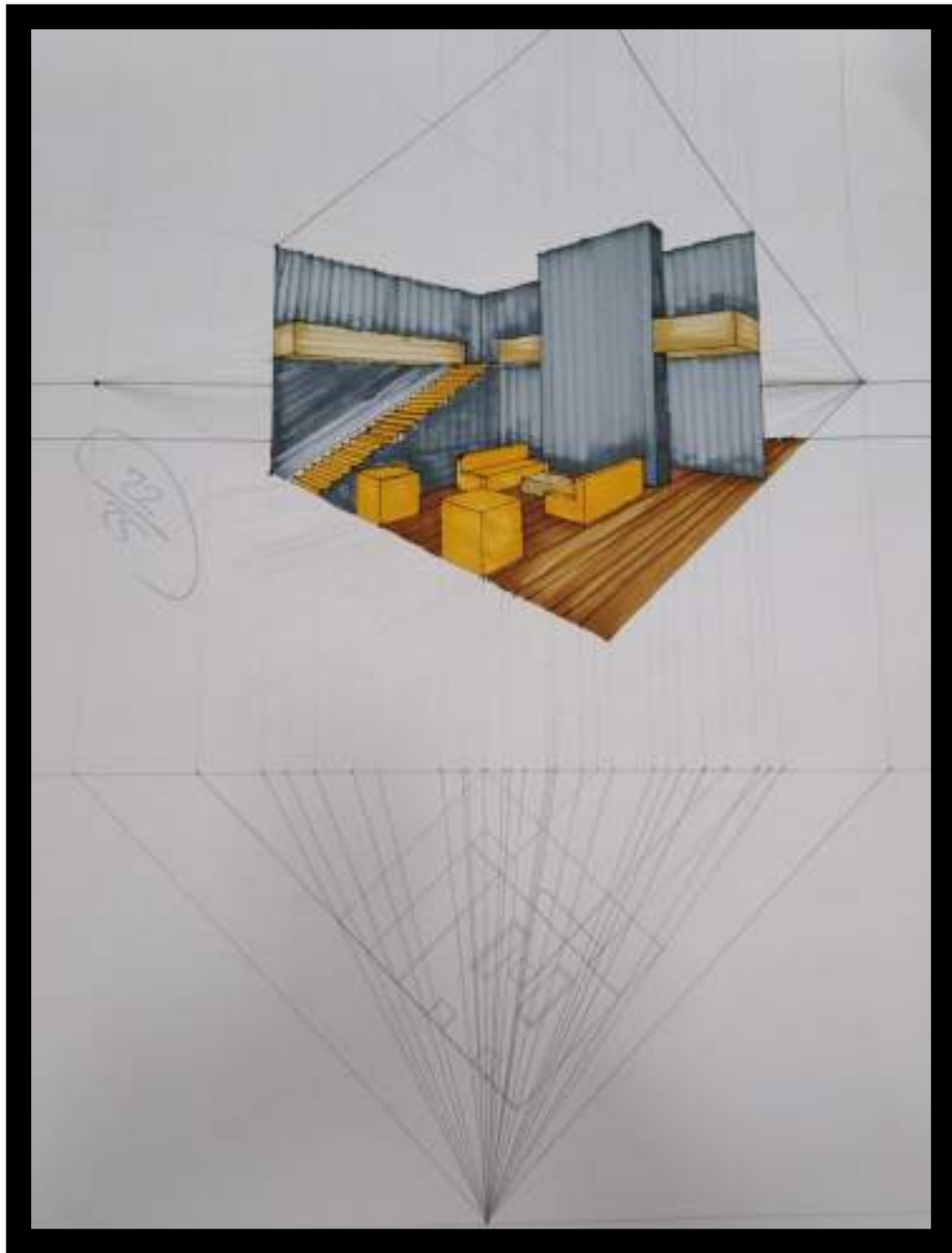

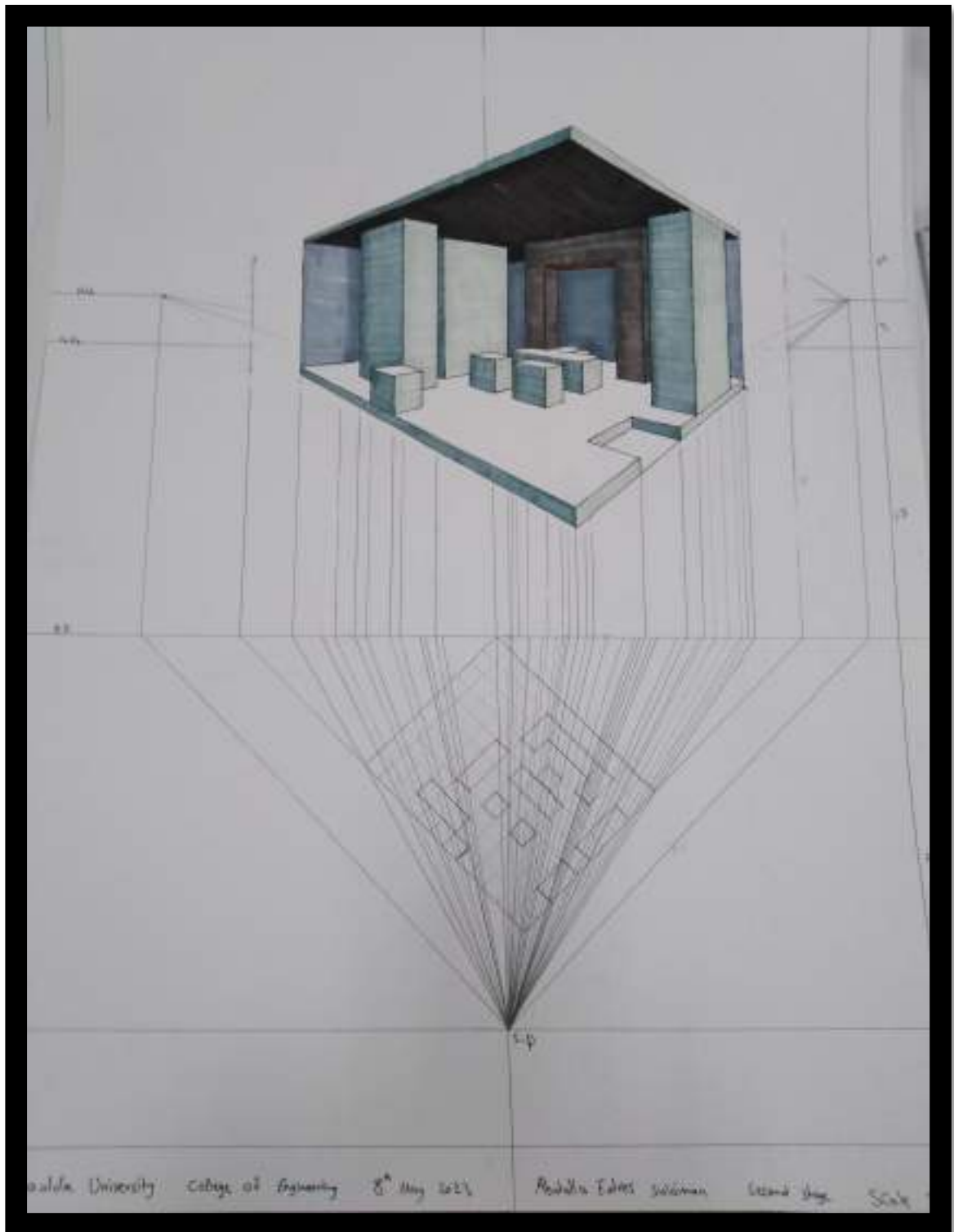

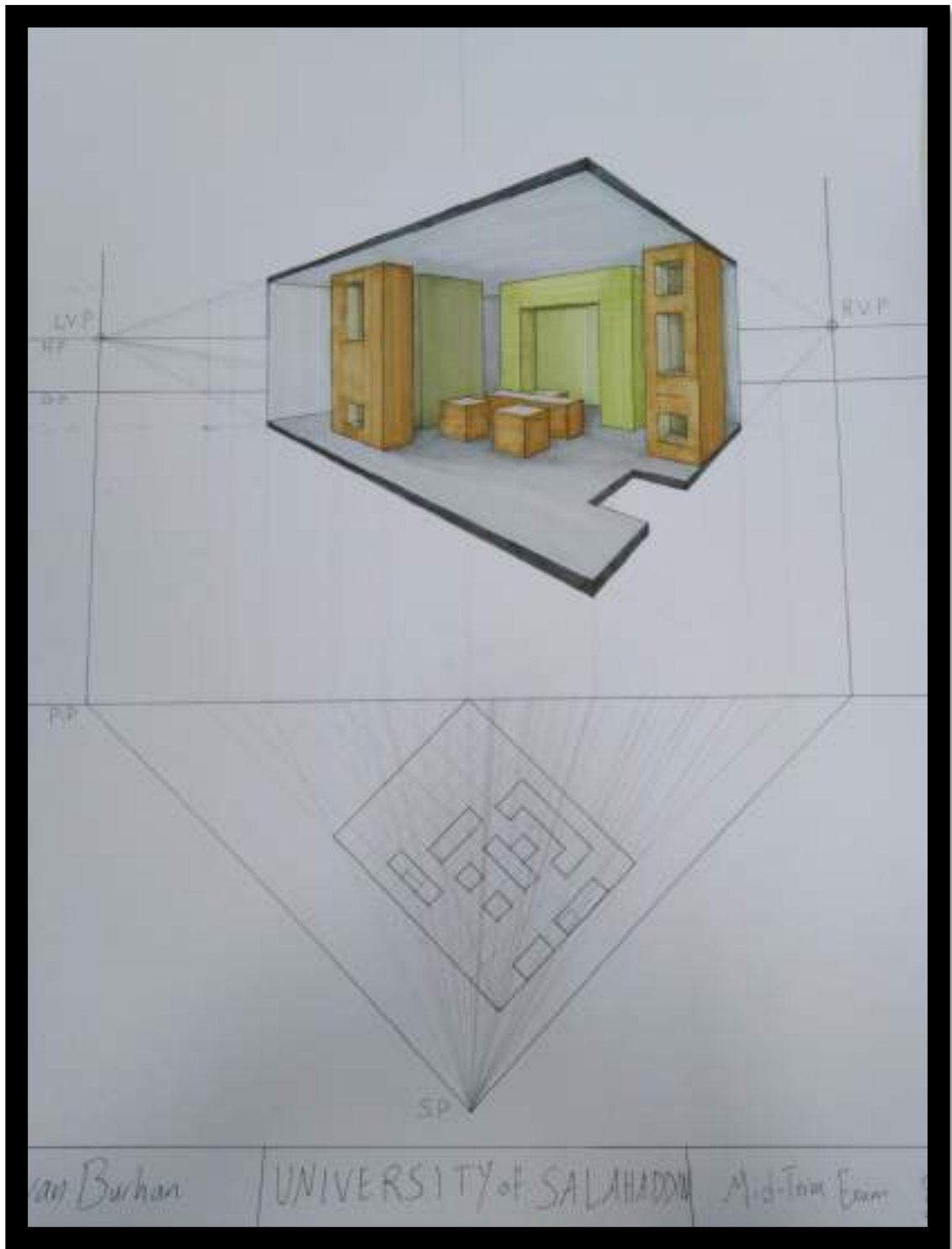

an Burhan

UNIVERSITY of SALAHADIN

Mid-Term Exam

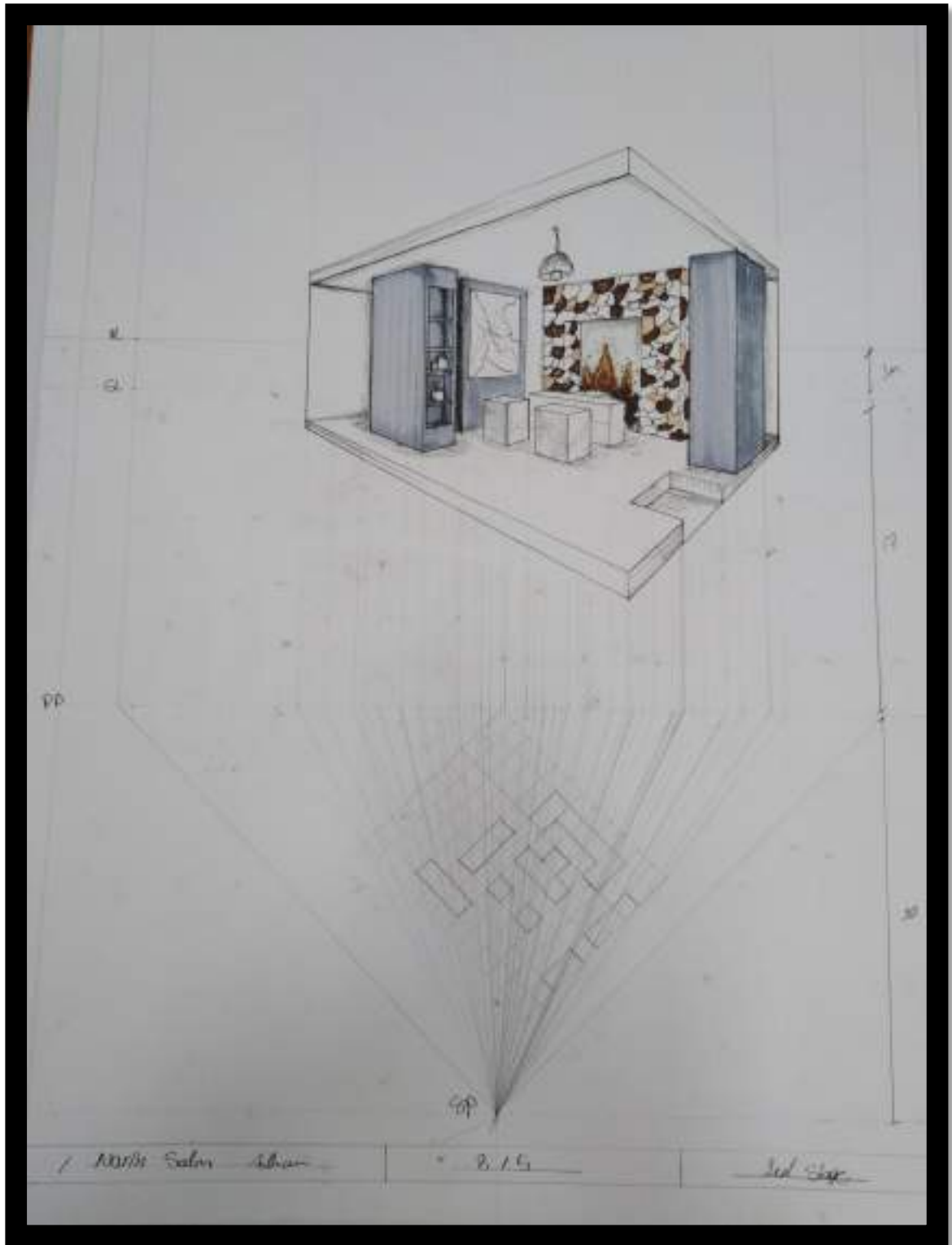

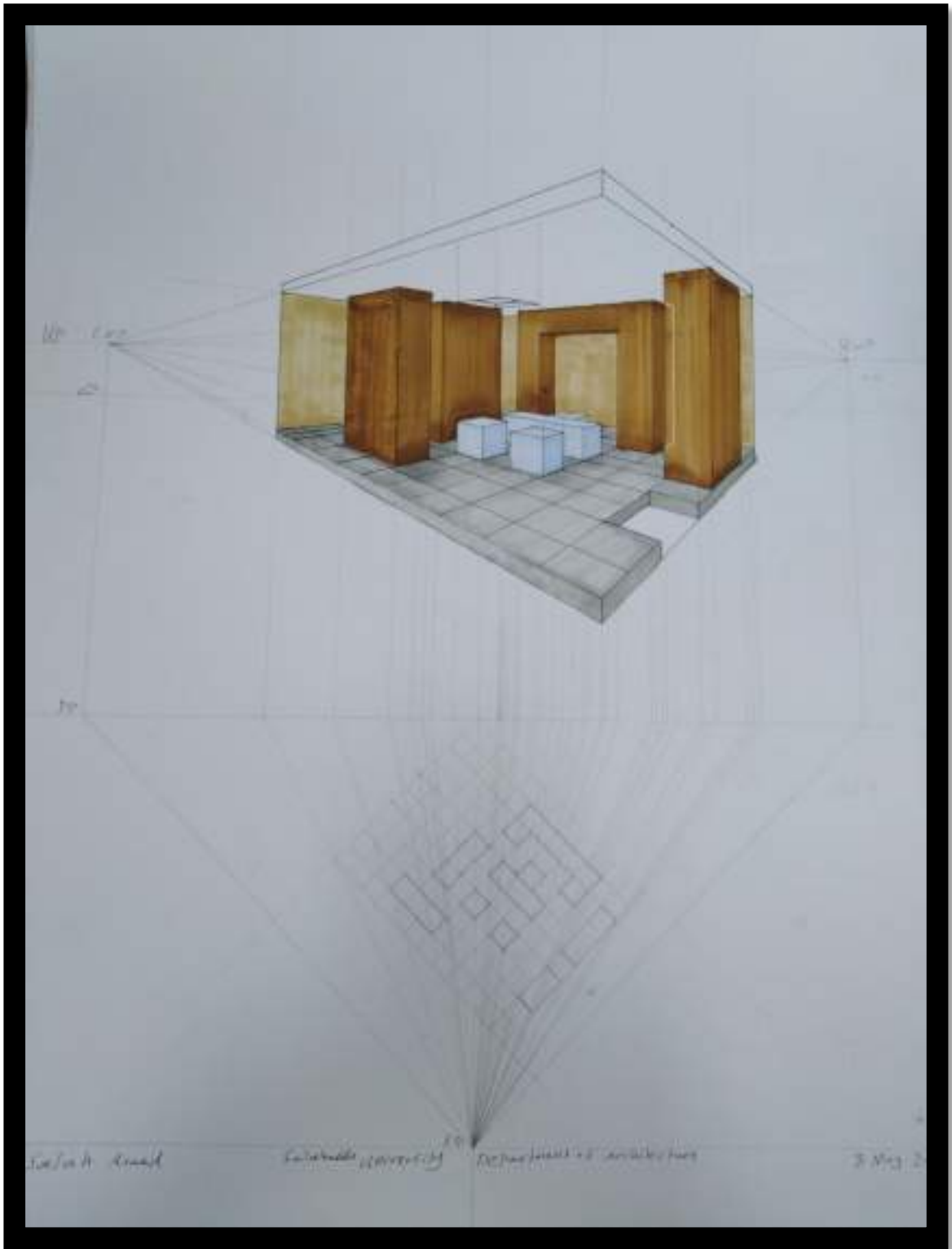

Luisa H. Knecht

Luisa H. Knecht

Department of Architecture

3 May 2012

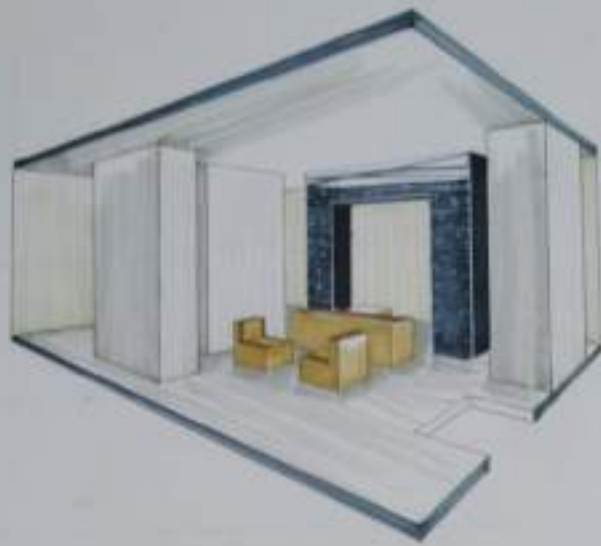

Mohammed Jashar

Sulhadin university
college of engineering

Scale : 1 : 100
2nd stage

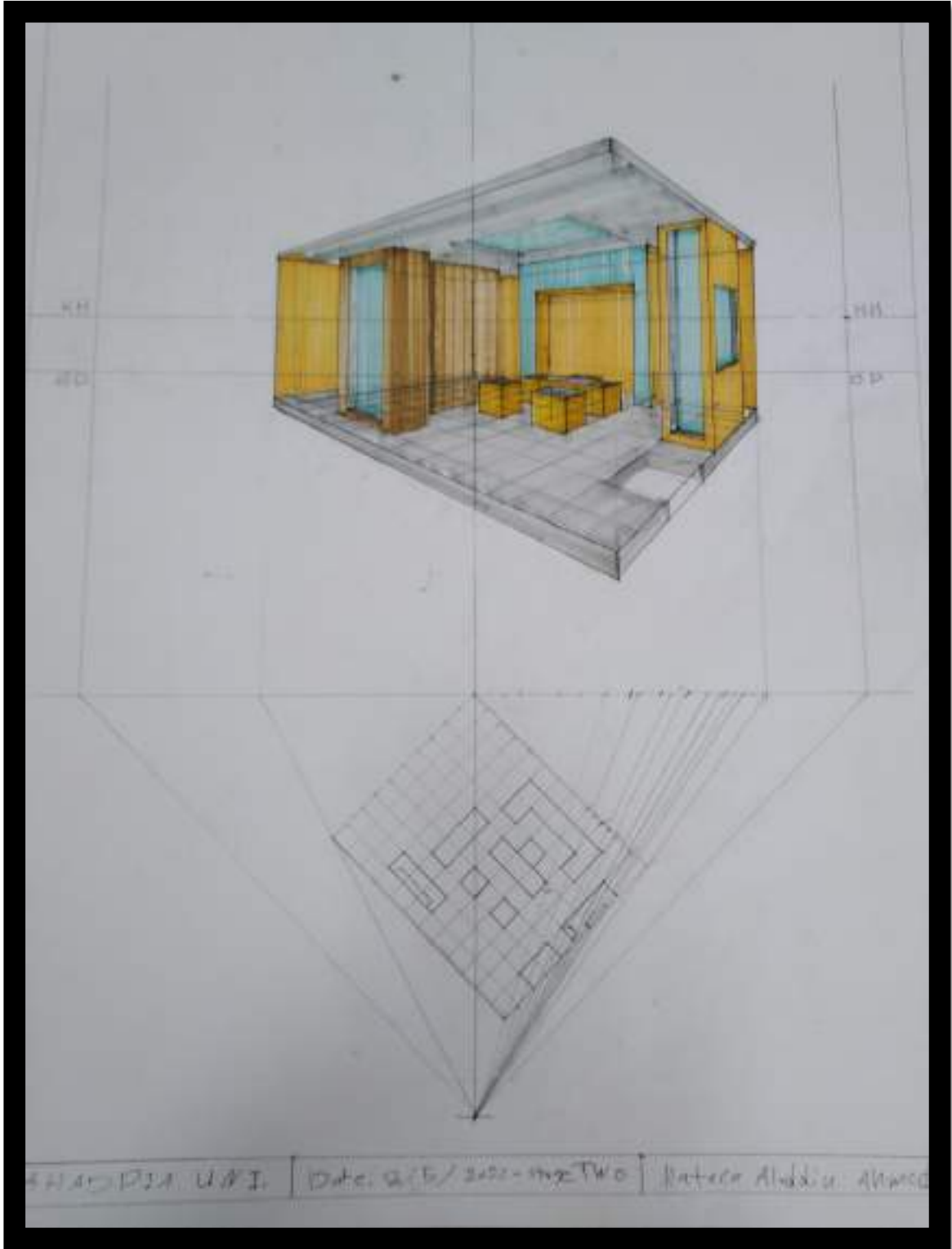

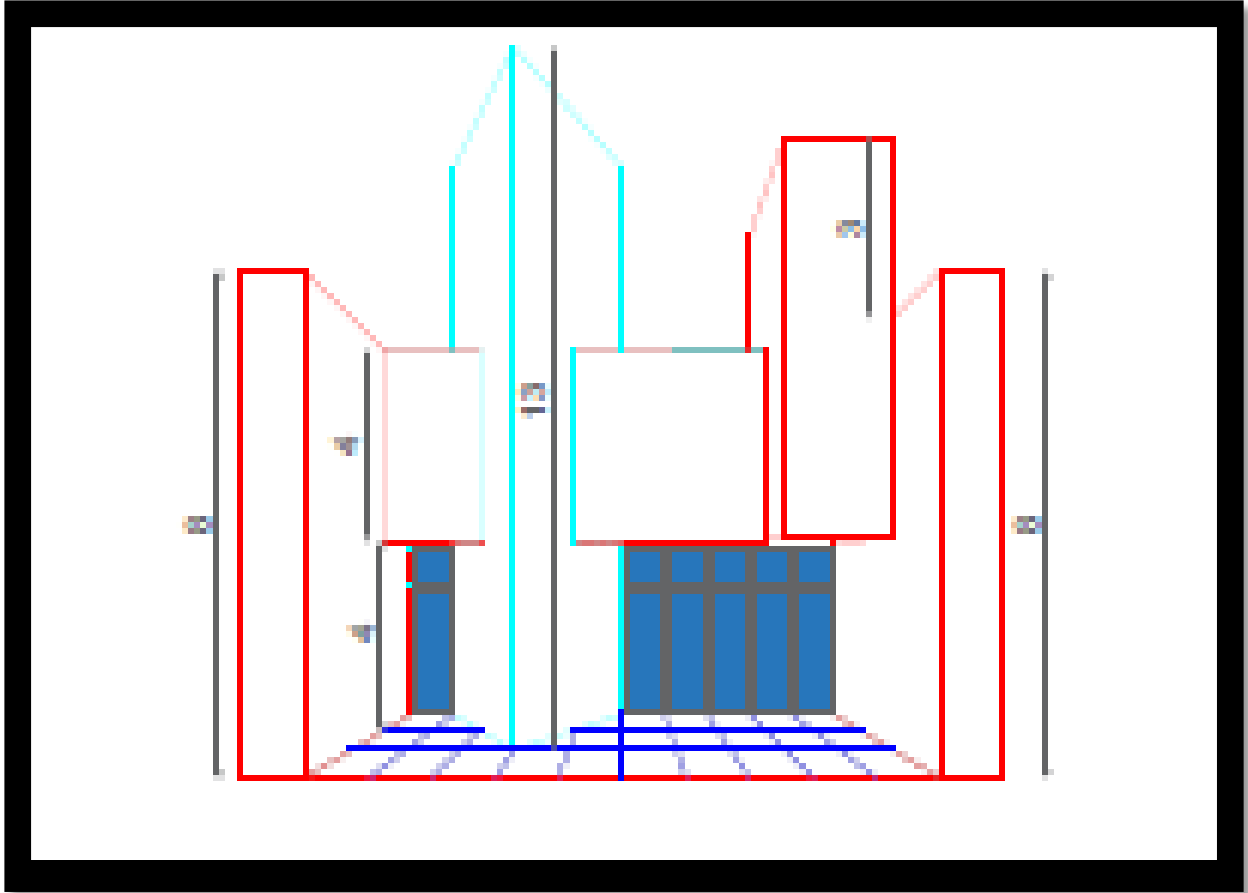

50

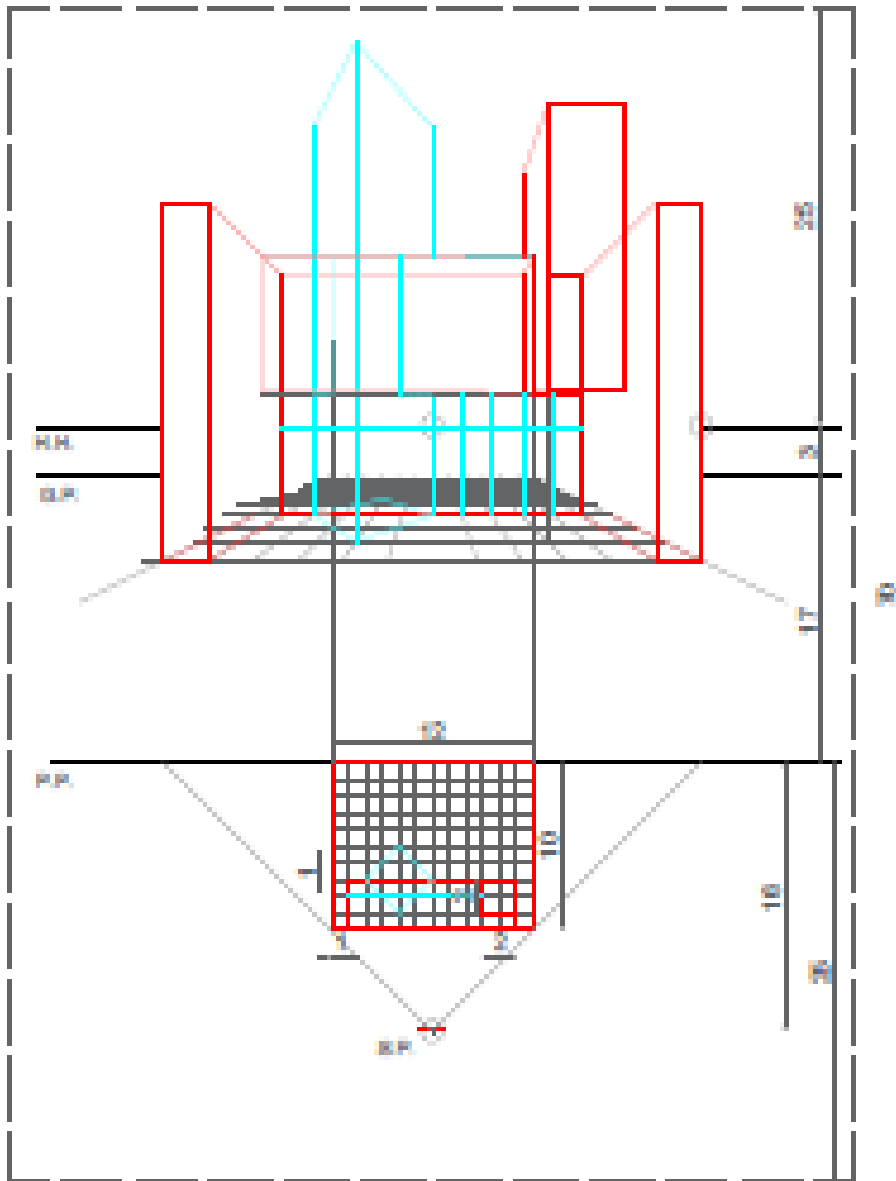

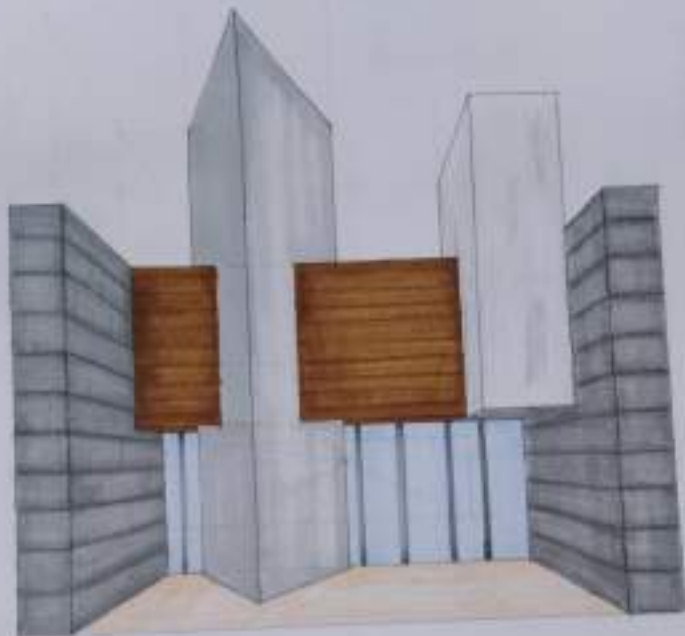

Hand-drawn Arch

ground floor

20/5/23

Picture Arch



11/11 2/5/2023

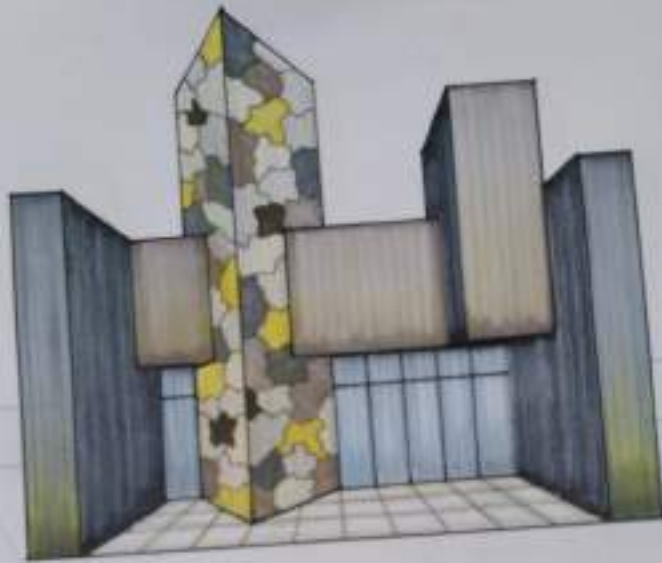

Handwritten text, possibly a signature or initials, enclosed in a faint oval shape.

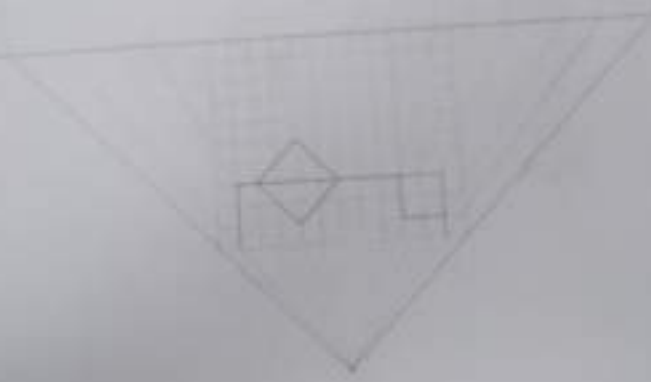

Handwritten text, possibly a signature or name, located at the bottom left of the page.

Handwritten text, possibly a signature or name, located at the bottom right of the page.



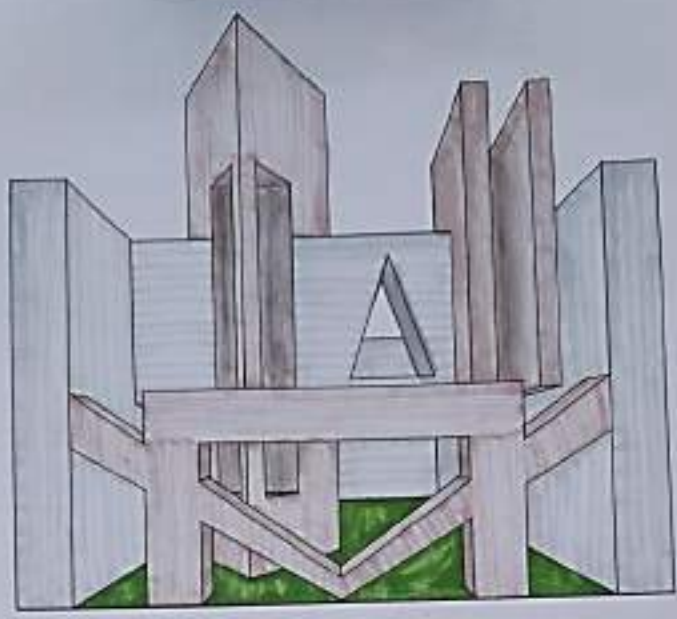

07/15

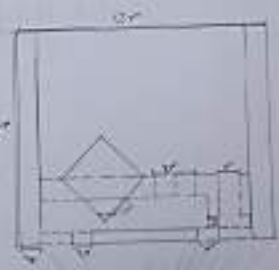

Zukunftsd heuen Betrus

Hw [8/15/2025]

Perspective & Präsentation

